



**ASRock**

**Z890 TAICHI**  
**LITE**

User Manual

## Contact Information

If you need to contact ASRock or want to know more about ASRock, you're welcome to visit ASRock's website at <http://www.asrock.com>; or you may contact your dealer for further information. For technical questions, please submit a support request form at <https://event.asrock.com/tsd.asp>

### **ASRock Incorporation**

e-mail: [info@asrock.com.tw](mailto:info@asrock.com.tw)

### **ASRock EUROPE B.V.**

e-mail: [sales@asrock.nl](mailto:sales@asrock.nl)

### **ASRock America, Inc.**

e-mail: [sales@asrockamerica.com](mailto:sales@asrockamerica.com)



Scan the QR code to view more manuals and documents.

# Contents

<b>Chapter 1 Introduction</b>	<b>1</b>
1.1 Package Contents	1
1.2 Specifications	2
1.3 Motherboard Layout	7
1.4 I/O Panel	9
1.5 Block Diagram	11
1.6 802.11be Wi-Fi 7 Module and ASRock WiFi 2.4/5/6 GHz Antenna	12
<b>Chapter 2 Installation</b>	<b>13</b>
2.1 Installing the CPU	15
2.2 Installing the CPU Fan and Heatsink	17
2.3 Installing Memory Modules (DIMM)	18
2.4 Connecting the Front Panel Header	20
2.5 Installing the Motherboard	21
2.6 Installing SATA Drives	22
2.7 Installing a Graphics Card	24
2.8 Connecting Peripheral Devices	26
2.9 Connecting the Power Connectors	27
2.10 Power On	28
2.11 Onboard Headers and Connectors	29
2.12 Smart Buttons	46
2.13 Dr. Debug	51

2.14	M.2 SSD Installation Guide (M2_1)	57
2.15	M.2 SSD Installation Guide (M2_2, M2_4 and M2_5)	60
2.16	M.2 SSD Installation Guide (M2_3)	63
2.17	M.2 SSD Installation Guide (M2_6)	66

# Chapter 1 Introduction

Thank you for purchasing ASRock Z890 Taichi Lite motherboard, a reliable motherboard produced under ASRock's consistently stringent quality control. It delivers excellent performance with robust design conforming to ASRock's commitment to quality and endurance.



*Because the motherboard specifications and the BIOS software might be updated, the content of this documentation will be subject to change without notice. In case any modifications of this documentation occur, the updated version will be available on ASRock's website without further notice. If you require technical support related to this motherboard, please visit our website for specific information about the model you are using. You may find the latest VGA cards and CPU support list on ASRock's website as well. ASRock website <http://www.asrock.com>.*

## 1.1 Package Contents

- ASRock Z890 Taichi Lite Motherboard (ATX Form Factor)
- 4 x Serial ATA (SATA) Data Cables (Optional)
- 1 x ASRock WiFi 2.4/5/6 GHz Antenna (Optional)
- 1 x ARGB Splitter Cable (Optional)
- 3 x Thermistor Cables (Optional)
- 2 x Screws for M.2 Sockets (Optional)
- 2 x Standoffs for M.2 Sockets (Optional)

## 1.2 Specifications

- Platform**
- ATX Form Factor
  - 8 Layer PCB
  - 2oz Copper PCB

- CPU**
- Supports Intel® Core™ Ultra Processors (Series 2) (LGA1851RL-ILM)
  - Supports Intel® Hybrid Technology
  - Supports Intel® Turbo Boost Max 3.0 Technology
  - Supports Intel® Thermal Velocity Boost (TVB)
  - Supports Intel® Adaptive Boost Technology (ABT)
  - Integrated NPU for dedicated AI acceleration
  - Supports ASRock Hyper BCLK Engine

- Chipset**
- Intel® Z890

- Memory**
- Dual Channel DDR5 Memory Technology
  - 4 x DDR5 DIMM Slots
  - Supports DDR5 non-ECC, un-buffered memory up to 9200+(OC)\*
  - Max. capacity of system memory: 256GB
  - Supports Intel® Extreme Memory Profile (XMP) 3.0x
- \* Please refer to Memory Support List on ASRock's website for more information. (<http://www.asrock.com/>)

- Expansion Slot**
- CPU:
- 1 x PCIe 5.0 x16 Slot (PCIE1), supports x16 mode\*
- Chipset:
- 1 x PCIe 4.0 x16 Slot (PCIE2), supports x4 mode\*
  - 1 x M.2 Socket (Key E), supports type 2230 WiFi/BT PCIe WiFi module

\* PCIE1 supports PCIe riser cards to extend one x16 slot to x8/x8 or x8/x4/x4 slots.

\* If PCIE2 is occupied, M2\_4 will be disabled.

\* Supports NVMe SSD as boot disks

**Graphics**

- Intel® UHD Graphics Built-in Visuals and the VGA outputs can be supported only with processors which are GPU integrated.
- Intel® X<sup>c</sup> LPG Graphics Architecture
- 1 x HDMI 2.1 TMDS/FRL 8G Compatible, supports HDR, HDCP 2.3 and max. resolution up to 4K 120Hz
- 2 x Intel® Thunderbolt™ 4, support HDCP 2.3 and max. resolution up to 8K 60Hz / 5K 120Hz\*

\* Supports two 4K displays or one 8K display

\* Only the CPU's embedded graphics can be displayed through Thunderbolt ports. If you want to display to a Thunderbolt monitor, please use CPU models with embedded graphics.

**Audio**

- 5.1 CH HD Audio with Content Protection (Realtek ALC4082 Audio Codec)
- WIMA Audio Capacitors (For Rear Outputs)
- ESS SABRE9219 DAC for Rear Panel Audio (130dB SNR)
- Individual PCB Layers for R/L Audio Channel
- Direct Drive Technology on Front headphone port (Supports up to 600 Ohm headsets)
- Nahimic Audio

**LAN**

**1 x 5 Gigabit LAN 10/100/1000/2500/5000 Mb/s (Realtek RTL8126)**

**1 x 2.5 Gigabit LAN 10/100/1000/2500 Mb/s (Dragon RTL-8125BG)**

- Supports Dragon 2.5G LAN Software
  - Smart Auto Adjust Bandwidth Control
  - Visual User Friendly UI
  - Visual Network Usage Statistics
  - Optimized Default Setting for Game, Browser, and Streaming Modes
  - User Customized Priority Control

**Wireless LAN**

- 802.11be 2x2 Wi-Fi 7 Module
- Supports IEEE 802.11a/b/g/n/ac/ax/axe/be
- Supports 2.4GHz/5GHz/6GHz\* frequency band
- Supports 320MHz channel bandwidth with 6GHz\* frequency band

\* Wi-Fi 7 (6GHz band) will be supported by Microsoft® Windows® 11. The availability will depend on the different regulation status of each country and region. It will be activated (for supported countries) through Windows Update and software updates once available.

- 1 antenna to support 2 (Transmit) x 2 (Receive) diversity technology
- Supports Bluetooth 5.4
- Supports MU-MIMO

## USB

CPU:

- 2 x Thunderbolt™ 4 Type-C (Rear)

Chipset:

- 1 x USB 3.2 Gen2x2 Type-C (Front)
- 4 x USB 3.2 Gen2 Type-A (Rear)
- 8 x USB 3.2 Gen1 (4 Rear, 4 Front)
- 6 x USB 2.0 (2 Rear, 4 Front)

\* All USB ports support ESD Protection

## Rear Panel I/O

- 2 x Antenna Ports
- 1 x HDMI Port
- 1 x Optical SPDIF Out Port
- 2 x Thunderbolt™ 4 Type-C Ports (40 Gb/s for USB4 protocol; 40Gb/s for Thunderbolt protocol)\*
- 4 x USB 3.2 Gen2 Type-A Ports (10 Gb/s)\*\*
- 4 x USB 3.2 Gen1 Ports\*\*
- 2 x USB 2.0 Ports
- 2 x RJ-45 LAN Ports
- 1 x Clear CMOS Button
- 1 x BIOS Flashback Button
- 1 x Line Out Jack (Gold Audio Jack)
- 1 x Microphone Input Jack (Gold Audio Jack)

\* Supports USB PD 3.0 up to 5V@3A (15W) charging

\*\* USB32\_56 are Lightning Gaming Ports. USB32\_34 support Ultra USB Power.



**Storage**

## CPU:

- 1 x Blazing M.2 Socket (M2\_1, Key M), supports type 2280 PCIe Gen5x4 (128 Gb/s) mode\*
- 1 x Hyper M.2 Socket (M2\_2, Key M), supports type 2260/2280 PCIe Gen4x4 (64 Gb/s) mode\*

## Chipset:

- 1 x Hyper M.2 Socket (M2\_3, Key M), supports type 2230/2242/2260/2280 SATA3 6.0 Gb/s & PCIe Gen4x4 (64 Gb/s) modes\*
- 1 x Hyper M.2 Socket (M2\_4, Key M), supports type 2260/2280 PCIe Gen4x4 (64 Gb/s) mode\*
- 1 x Hyper M.2 Socket (M2\_5, Key M), supports type 2260/2280 PCIe Gen4x4 (64 Gb/s) mode\*
- 1 x Hyper M.2 Socket (M2\_6, Key M), supports type 2260/2280 PCIe Gen4x4 (64 Gb/s) mode\*
- 4 x SATA3 6.0 Gb/s Connectors

\* Supports Intel® Volume Management Device (VMD)

\* Supports NVMe SSD as boot disks

\* If PCIe2 is occupied, M2\_4 will be disabled.

**RAID**

- Supports RAID 0, RAID 1, RAID 5 and RAID 10 for SATA storage devices
- Supports RAID 0, RAID 1, RAID 5 and RAID 10 for M.2 NVMe storage devices

**Connector**

- 3 x Thermistor Cable Headers
- 1 x SPI TPM Header
- 1 x Power LED and Speaker Header
- 1 x RGB LED Header\*
- 3 x Addressable LED Headers\*\*
- 2 x CPU Fan Connector (4-pin) (Smart Fan Speed Control)\*\*\*
- 4 x Chassis Fan Connectors (4-pin) (Smart Fan Speed Control)\*\*\*
- 1 x AIO Pump Fan Connector (4-pin) (Smart Fan Speed Control)\*\*\*
- 1 x Water Pump Fan Connector (4-pin) (Smart Fan Speed Control)\*\*\*

- 1 x 24 pin ATX Power Connector (Hi-Density Power Connector)
- 2 x 8 pin 12V Power Connectors (Hi-Density Power Connector)
- 1 x Front Panel Audio Connector (15μ Gold Audio Connector)
- 2 x USB 2.0 Headers (Support 4 USB 2.0 ports)
- 2 x USB 3.2 Gen1 Headers (Support 4 USB 3.2 Gen1 ports)
- 1 x Front Panel Type C USB 3.2 Gen2x2 Header (20 Gb/s)
- 1 x Dr. Debug with LED
- 1 x Power Button with LED
- 1 x Reset Button with LED

\* Supports in total up to 12V/3A, 36W LED Strip

\*\* Support in total up to 5V/3A, 15W LED Strip

\*\*\* CPU\_FAN1 supports the fan power up to 1A (12W).

\*\*\* CPU\_FAN2, CHA\_FAN1~4, AIO\_PUMP and W\_PUMP support the fan power up to 3A (36W).

\*\*\* CPU\_FAN2, CHA\_FAN1~4, AIO\_PUMP and W\_PUMP can auto detect if 3-pin or 4-pin fan is in use.

**BIOS  
Feature**

- AMI UEFI Legal BIOS with GUI support

**OS**

- Microsoft® Windows® 11 64-bit

**Certifica-  
tions**

- FCC, CE
- ErP/EuP ready (ErP/EuP ready power supply is required)
- CEC Tier II ready

\* For detailed product information, please visit our website: <http://www.asrock.com>



Please realize that there is a certain risk involved with overclocking, including adjusting the setting in the BIOS, applying Untied Overclocking Technology, or using third-party overclocking tools. Overclocking may affect your system's stability, or even cause damage to the components and devices of your system. It should be done at your own risk and expense. We are not responsible for possible damage caused by overclocking.

### 1.3 Motherboard Layout

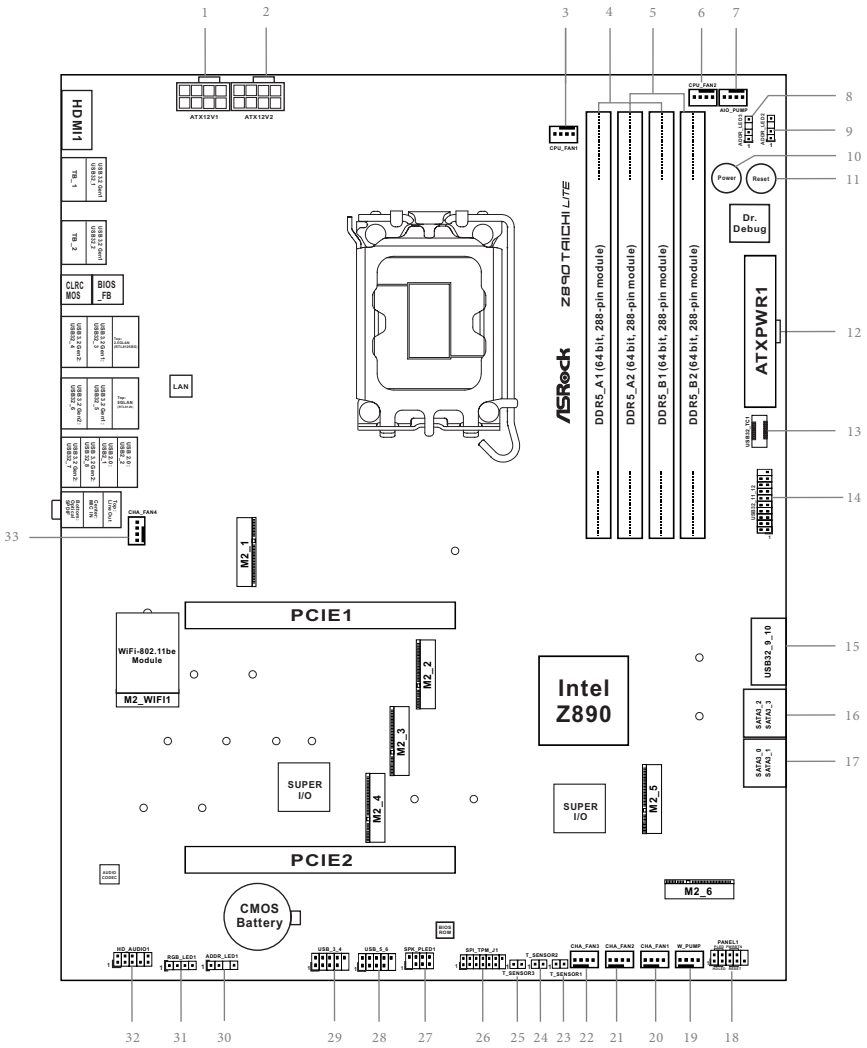

No.	Description
1	ATX 12V Power Connector (ATX12V1)
2	ATX 12V Power Connector (ATX12V2)
3	CPU Fan Connector (CPU_FAN1)
4	2 x 288-pin DDR5 DIMM Slots (DDR5_A1, DDR5_B1)
5	2 x 288-pin DDR5 DIMM Slots (DDR5_A2, DDR5_B2)
6	CPU Fan Connector (CPU_FAN2)
7	AIO Pump Fan Connector (AIO_PUMP)
8	Addressable LED Header (ADDR_LED3)
9	Addressable LED Header (ADDR_LED2)
10	Power Button (PWRBTN1)
11	Reset Button (RSTBTN1)
12	ATX Power Connector (ATXPWR1)
13	Front Panel Type C USB 3.2 Gen2x2 Header (USB32_TC1)
14	USB 3.2 Gen1 Header (USB32_11_12)
15	USB 3.2 Gen1 Header (USB32_9_10)
16	SATA3 Connectors (SATA3_2)(Upper), (SATA3_3)(Lower)
17	SATA3 Connectors (SATA3_0)(Upper), (SATA3_1)(Lower)
18	System Panel Header (PANEL1)
19	Water Pump Fan Connector (W_PUMP)
20	Chassis Fan Connector (CHA_FAN1)
21	Chassis Fan Connector (CHA_FAN2)
22	Chassis Fan Connector (CHA_FAN3)
23	Thermistor Cable Header (T_SENSOR1)
24	Thermistor Cable Header (T_SENSOR2)
25	Thermistor Cable Header (T_SENSOR3)
26	SPI TPM Header (SPI_TPM_J1)
27	Power LED and Speaker Header (SPK_PLED1)
28	USB 2.0 Header (USB_5_6)
29	USB 2.0 Header (USB_3_4)
30	Addressable LED Header (ADDR_LED1)
31	RGB LED Header (RGB_LED1)
32	Front Panel Audio Header (HD_AUDIO1)
33	Chassis Fan Connector (CHA_FAN4)

## 1.4 I/O Panel

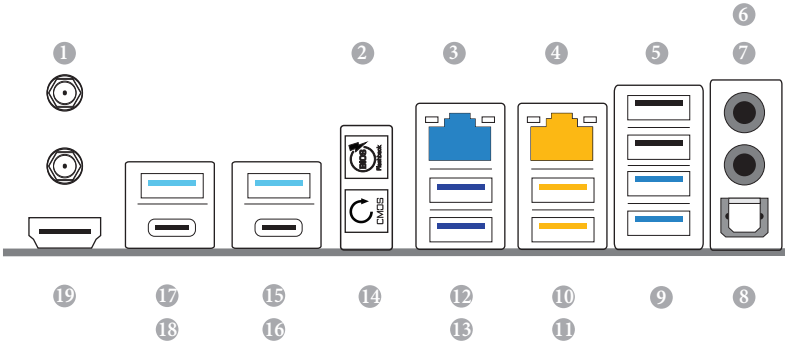

No.	Description	No.	Description
1	Antenna Ports	11	USB 3.2 Gen2 Type-A Port (USB32_6)****
2	BIOS Flashback Button	12	USB 3.2 Gen1 Type-A Port (USB32_3)****
3	2.5G LAN RJ-45 Port (Dragon RTL8125BG)*	13	USB 3.2 Gen2 Type-A Port (USB32_4)****
4	5G LAN RJ-45 Port (Realtek RTL8126-VB)**	14	Clear CMOS Button
5	USB 2.0 Ports (USB_12)	15	USB 3.2 Gen1 Type-A Port (USB32_2)
6	Line Out Jack***	16	Thunderbolt™ 4 Type-C Port (TB_2)
7	Microphone Input Jack***	17	USB 3.2 Gen1 Type-A Port (USB32_1)
8	Optical SPDIF Out Port	18	Thunderbolt™ 4 Type-C Port (TB_1)
9	USB 3.2 Gen2 Type-A Ports (USB32_78)	19	HDMI Port
10	USB 3.2 Gen1 Type-A Port (USB32_5)****		

\*There are two LEDs on each LAN port. Please refer to the table below for the LAN port LED indications.

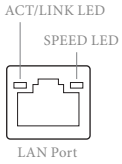

Activity / Link LED		Speed LED	
Status	Description	Status	Description
Off	No Link	Off	10Mbps connection
Blinking	Data Activity	Orange	100Mbps/1Gbps connection
On	Link	Green	2.5Gbps connection

\*\*There are two LEDs on each LAN port. Please refer to the table below for the LAN port LED indications.

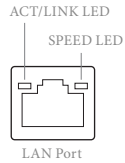

Activity / Link LED		Speed LED	
Status	Description	Status	Description
Off	No Link	Off	10Mbps connection
Blinking	Data Activity	Orange	100Mbps/1Gbps/2.5 connection
On	Link	Green	5Gbps connection connection

\*\*\* **Function of the Audio Ports in 2, 4 or 5.1-channel Configuration:**

Channel	Port	Function
2ch	Line Out Jack (Rear Panel)	Front speaker out
4ch	Pink-Mic (Front Panel)	Rear speaker out
5.1ch	Microphone Input Jack (Rear Panel)	Central/Subwoofer speaker out

\*\*\*\* Ultra USB Power is supported on USB32\_34 ports. ACPI wake-up function is not supported on USB32\_34 ports. USB32\_56 are Lightning Gaming Ports.

# 1.5 Block Diagram

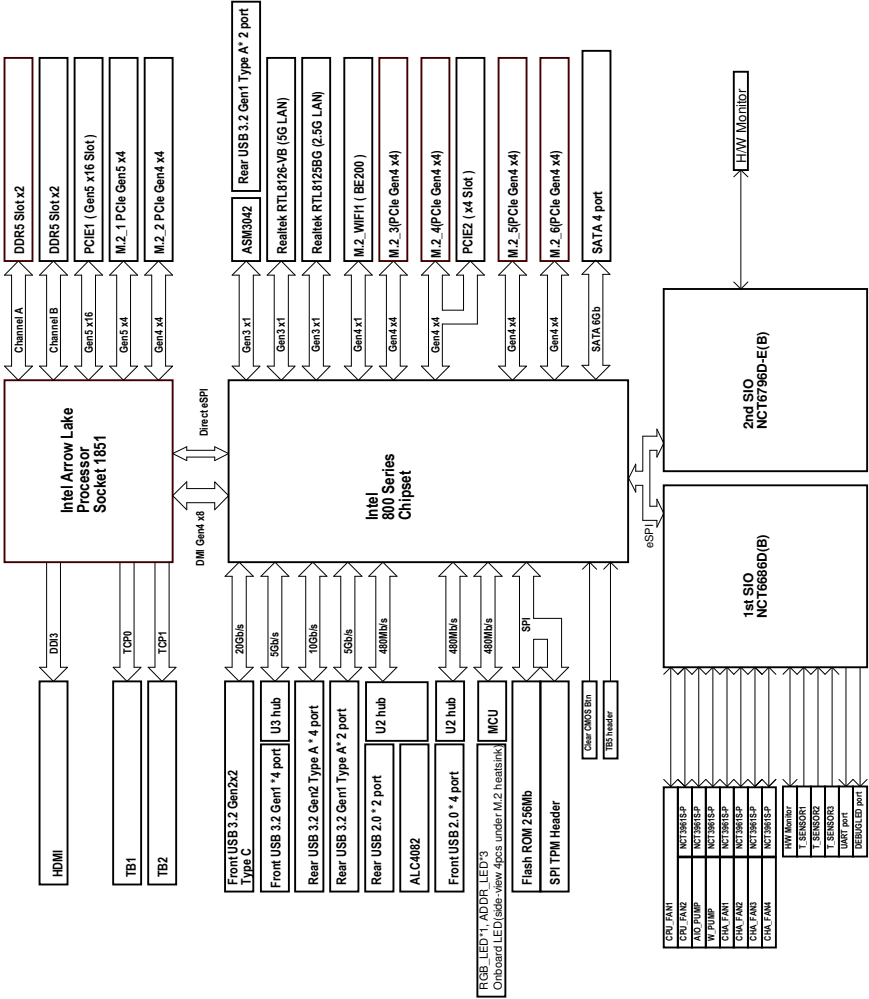

---

## 1.6 802.11be Wi-Fi 7 Module and ASRock WiFi 2.4/5/6 GHz Antenna

### 802.11be Wi-Fi 7 + BT Module

This motherboard comes with an exclusive 802.11 a/b/g/n/ac/ax/axe/be Wi-Fi 7 + BT v5.4 module that offers support for 802.11 a/b/g/n/ac/ax/axe/be Wi-Fi 7 connectivity standards and Bluetooth v5.4. Wi-Fi 7 + BT module is an easy-to-use wireless local area network (WLAN) adapter to support Wi-Fi 7 + BT. Bluetooth v5.4 standard features Smart Ready technology that adds a whole new class of functionality into the mobile devices.

\* The transmission speed may vary according to the environment.

\* Wi-Fi 7 (6GHz band) will be supported by Microsoft® Windows® 11. The availability will depend on the different regulation status of each country and region. It will be activated (for supported countries) through Windows Update and software updates once available.



## Chapter 2 Installation

This is an ATX form factor motherboard. Before you install the motherboard, study the configuration of your chassis to ensure that the motherboard fits into it.

### Pre-installation Precautions

Take note of the following precautions before you install motherboard components or change any motherboard settings.

- Make sure to unplug the power cord before installing or removing the motherboard components. Failure to do so may cause physical injuries and damages to motherboard components.
- In order to avoid damage from static electricity to the motherboard's components, NEVER place your motherboard directly on a carpet. Also remember to use a grounded wrist strap or touch a safety grounded object before you handle the components.
- Hold components by the edges and do not touch the ICs.
- Whenever you uninstall any components, place them on a grounded anti-static pad or in the bag that comes with the components.
- When placing screws to secure the motherboard to the chassis, please do not over-tighten the screws! Doing so may damage the motherboard.

**DO NOT** remove this Memory OC Shield (patent pending) from the motherboard.  
Removing this may affect memory overlocking performance and stability.

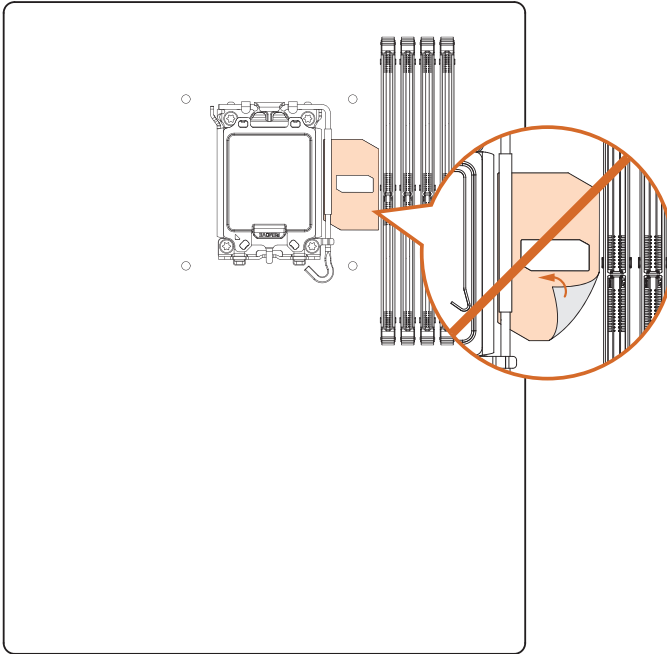

*The illustration shown here is for reference only and may not be an exact representation of your motherboard's layout.*

## 2.1 Installing the CPU

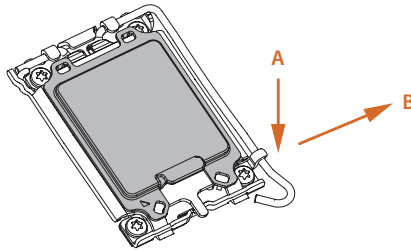
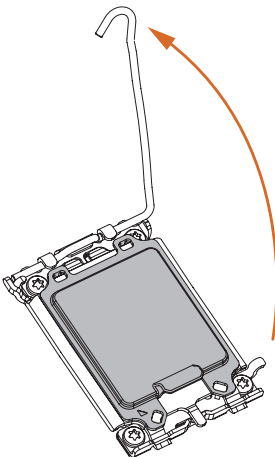
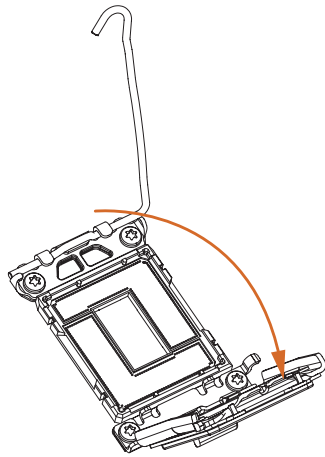

1. Before you insert the 1851-Pin CPU into the socket, please check if the **PnP cap** is on the socket, if the CPU surface is unclean, or if there are any **bent pins** in the socket. Do not force to insert the CPU into the socket if above situation is found. Otherwise, the CPU will be seriously damaged.
2. Unplug all power cables before installing the CPU to prevent hardware damage.
3. Use the CPU cooler with a minimum of 35lb of static compressive load for the LGA1851 RL-ILM (Reduced Load Independent Loading Mechanism) socket.

**1****2****3**

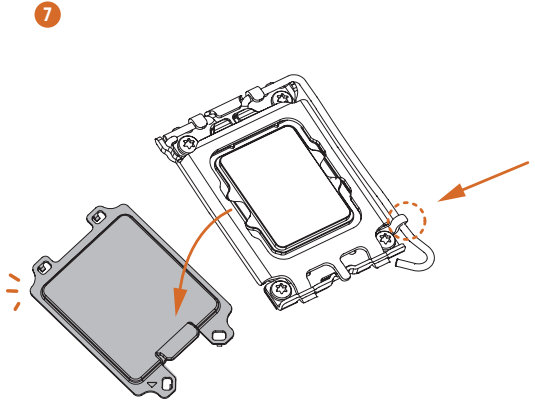
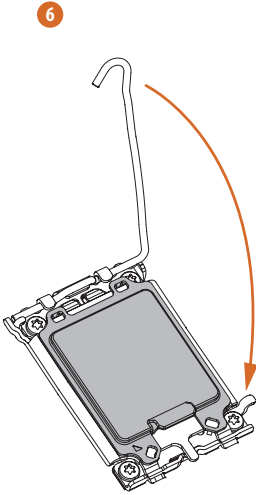
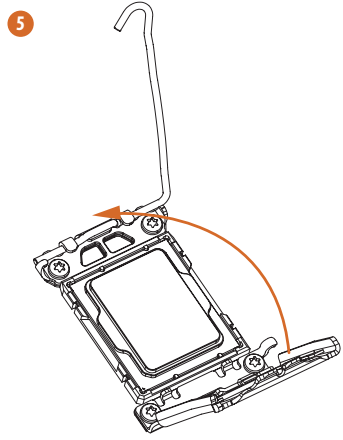
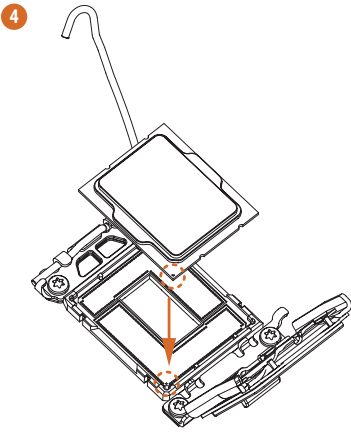

*Please save and replace the cover if the processor is removed. The cover must be placed if you wish to return the motherboard for after service.*

## 2.2 Installing the CPU Fan and Heatsink

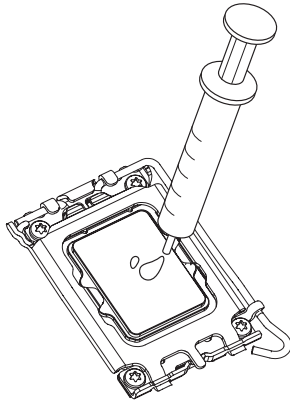
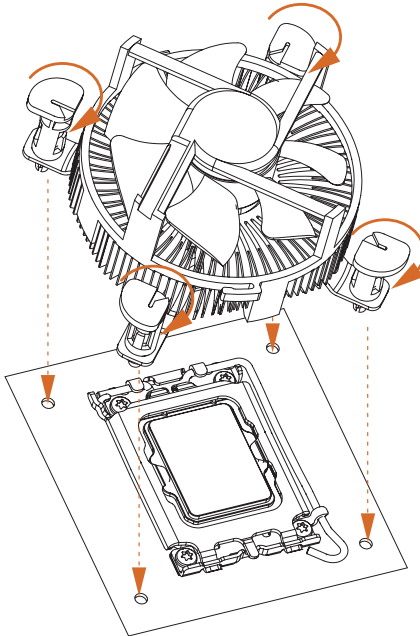
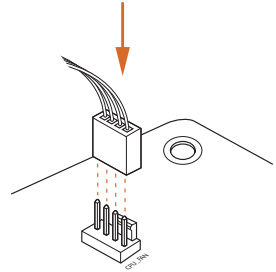
**1****2**

## 2.3 Installing Memory Modules (DIMM)

This motherboard provides four 288-pin DDR5 (Double Data Rate 5) DIMM slots, and supports Dual Channel Memory Technology.



1. For dual channel configuration, you always need to install identical (the same brand, speed, size and chip-type) DDR5 DIMM pairs.
2. It is unable to activate Dual Channel Memory Technology with only one or three memory module installed.
3. It is not allowed to install a DDR, DDR2, DDR3 or DDR4 memory module into a DDR5 slot; otherwise, this motherboard and DIMM may be damaged.
4. The DIMM only fits in one correct orientation. It will cause permanent damage to the motherboard and the DIMM if you force the DIMM into the slot at incorrect orientation.

### Recommended Memory Configuration

#### 1 DIMM



#### 2 DIMMs



#### 4 DIMMs



1

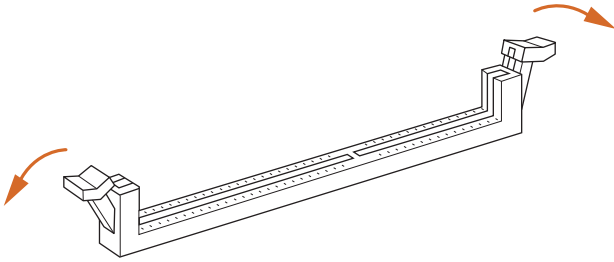

2

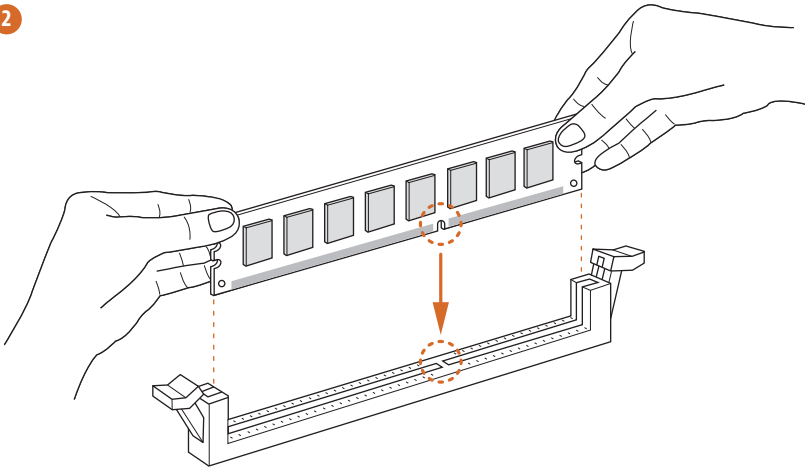

3

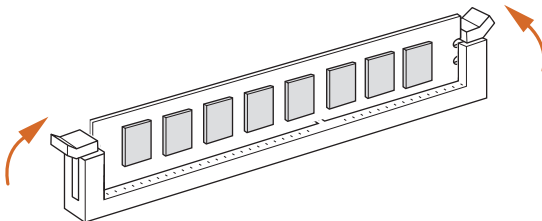

## 2.4 Connecting the Front Panel Header

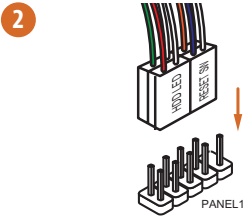
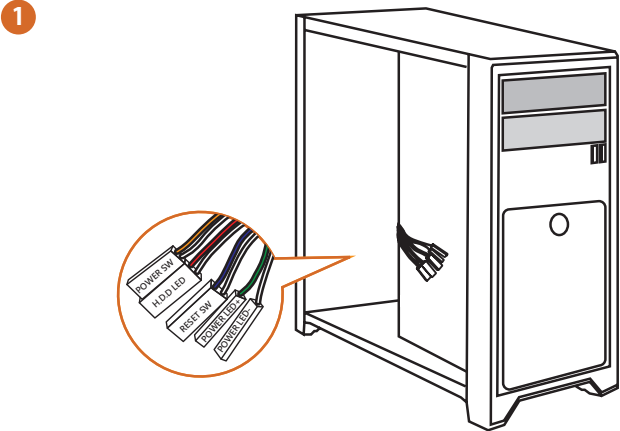

System Panel Header

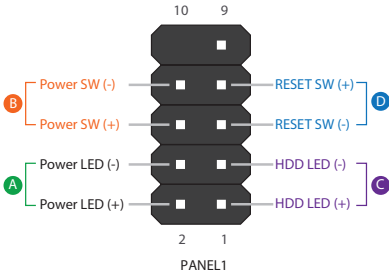

Front Panel Wires

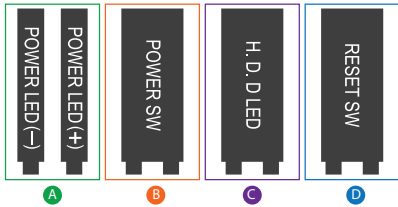



## 2.5 Installing the Motherboard

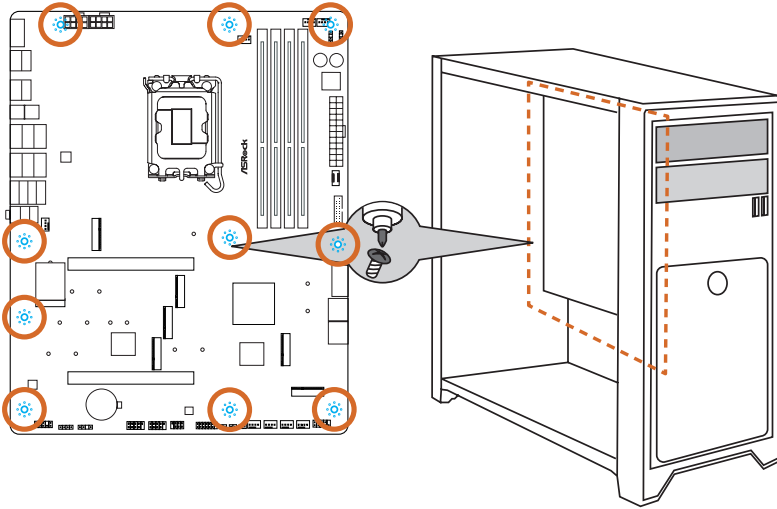

## 2.6 Installing SATA Drives

1

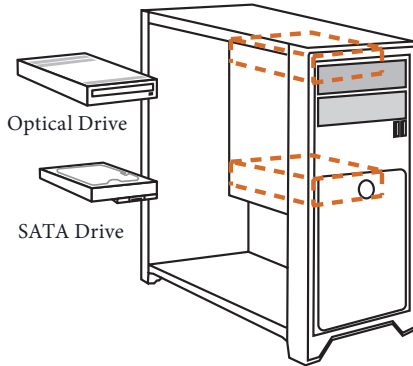

2

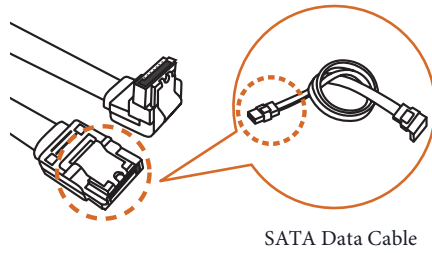

3

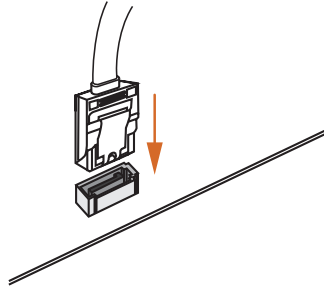

4

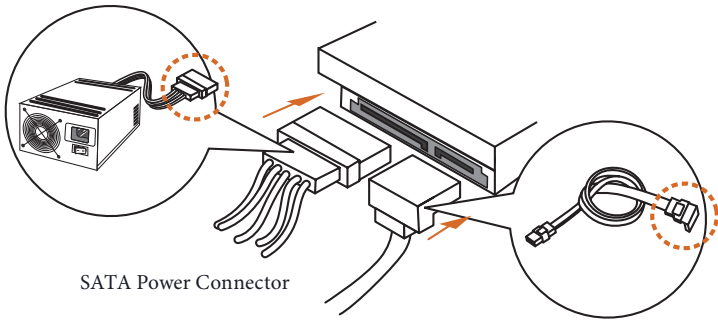

SATA Power Connector

SATA Data Connector

## 2.7 Installing a Graphics Card

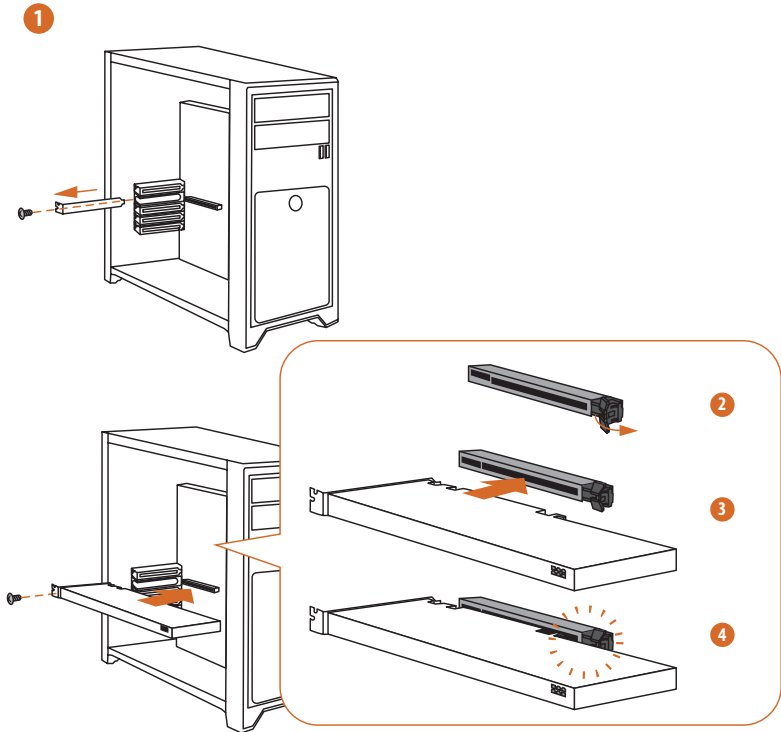

## Expansion Slots (PCIe Slots)

There are 2 PCI Express slots on the motherboard.



*Before installing an expansion card, please make sure that the power supply is switched off or the power cord is unplugged. Please read the documentation of the expansion card and make necessary hardware settings for the card before you start the installation.*

### **PCIe slots:**

PCIE1 (PCIe 5.0 x16 slot) is used for PCIe x16 lane width graphics cards.

PCIE2 (PCIe 4.0 x16 slot) is used for PCIe x4 lane width graphics cards.

\* PCIE1 supports PCIe riser cards to extend one x16 slot to x8/x8 or x8/x4/x4 slots.

\* If PCIE2 is occupied, M2\_4 will be disabled.

## 2.8 Connecting Peripheral Devices

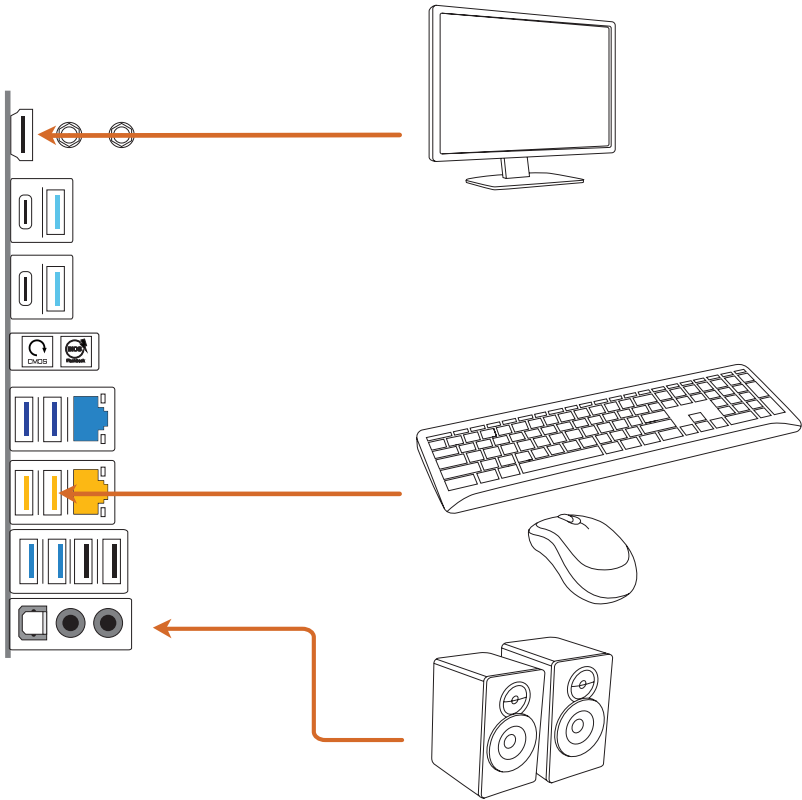

## 2.9 Connecting the Power Connectors

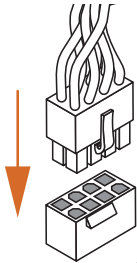
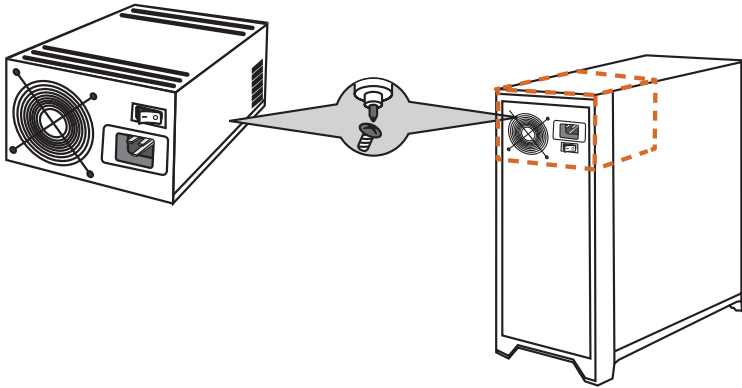

ATX12V1

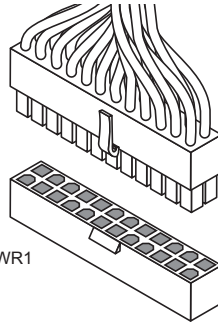

ATXPWR1

## 2.10 Power On

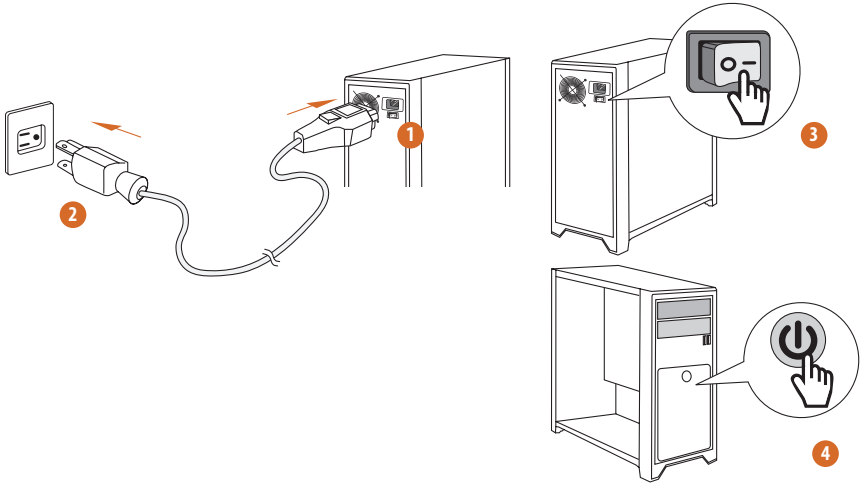



## 2.11 Onboard Headers and Connectors



Onboard headers and connectors are NOT jumpers. Do NOT place jumper caps over these headers and connectors. Placing jumper caps over the headers and connectors will cause permanent damage to the motherboard.

### System Panel Header

(9-pin PANEL1) (see p.7, No. 18)

Connect the power button, reset button and system status indicator on the chassis to this header according to the pin assignments below. Note the positive and negative pins before connecting the cables.

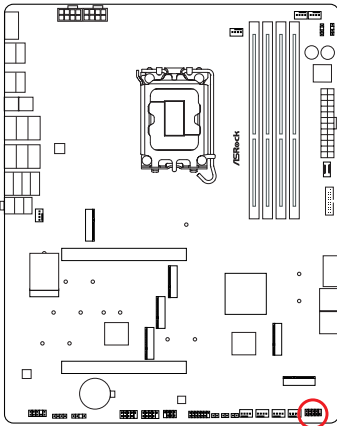

PANEL1

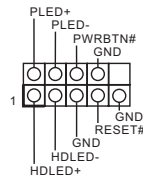

#### **PWRBTN (Power Button):**

Connect to the power button on the chassis front panel. You may configure the way to turn off your system using the power button.

#### **RESET (Reset Button):**

Connect to the reset button on the chassis front panel. Press the reset button to restart the computer if the computer freezes and fails to perform a normal restart.

#### **PLED (System Power LED):**

Connect to the power status indicator on the chassis front panel. The LED is on when the system is operating. The LED keeps blinking when the system is in S1/S3 sleep state. The LED is off when the system is in S4 sleep state or powered off (S5).

#### **HDLED (Hard Drive Activity LED):**

Connect to the hard drive activity LED on the chassis front panel. The LED is on when the hard drive is reading or writing data.

The front panel design may differ by chassis. A front panel module mainly consists of power button, power LED, hard drive activity LED, speaker and etc. When connecting your chassis front panel module to this header, make sure the wire assignments and the pin assignments are matched correctly.

Power LED and Speaker Header  
(7-pin SPK\_PLED1) (see p.7, No. 27)

Please connect the chassis power LED and the chassis speaker to this header.

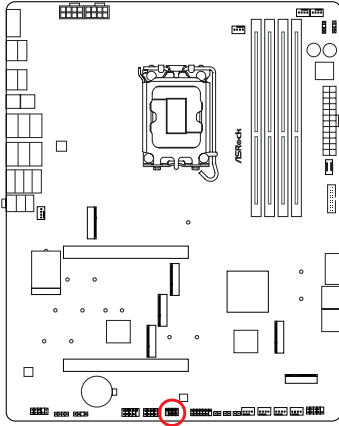

SPK\_PLED1

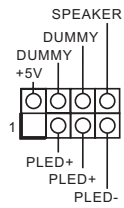

### Serial ATA3 Connectors

#### Right Angle:

(SATA3\_0) (see p.7, No. 17)(Upper)

(SATA3\_1) (see p.7, No. 17)(Lower)

(SATA3\_2) (see p.7, No. 16)(Upper)

(SATA3\_3) (see p.7, No. 16)(Lower)

These four SATA3 connectors support SATA data cables for internal storage devices with up to 6.0 Gb/s data transfer rate.

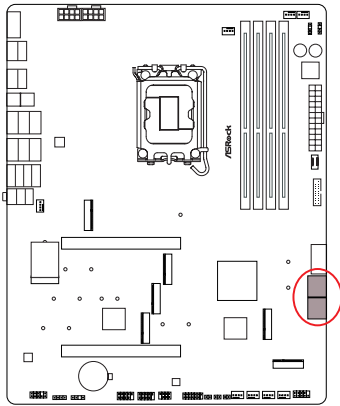

SATA3\_0 SATA3\_2  
SATA3\_1 SATA3\_3

## USB 2.0 Headers

(9-pin USB\_3\_4) (see p.7, No. 29)

(9-pin USB\_5\_6) (see p.7, No. 28)

There are two headers on this motherboard. Each USB 2.0 header can support two ports.

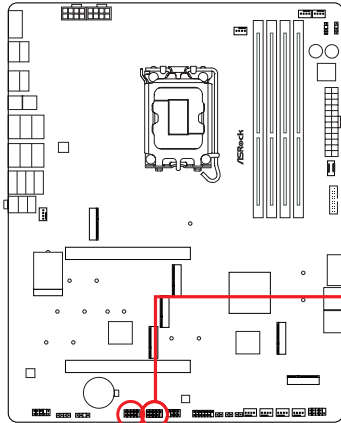

USB\_5\_6

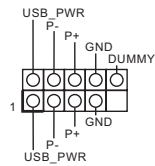

USB\_3\_4

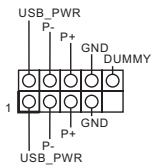

USB 3.2 Gen1 Headers

Right Angle:

(19-pin USB32\_9\_10) (see p.7, No. 15)

Vertical:

(19-pin USB32\_11\_12) (see p.7, No. 14)

There are two headers on this motherboard. Each USB 3.2 Gen1 header can support two ports.

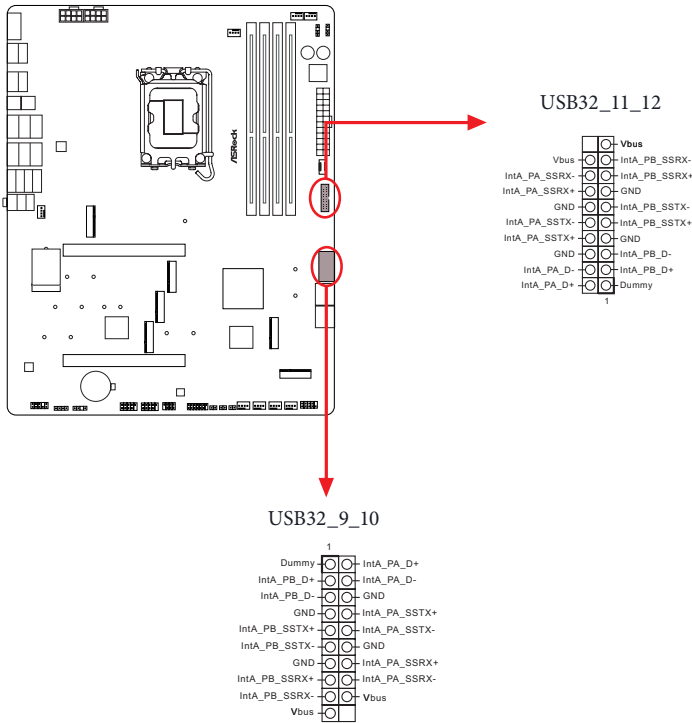

Front Panel Type C USB 3.2 Gen2x2 Header  
(20-pin USB32\_TC1) (see p.7, No. 13)

There is one Front Panel Type C USB 3.2 Gen2x2 Header on this motherboard.  
This header is used for connecting a USB 3.2 Gen2x2 module for additional USB 3.2 Gen2x2 ports.

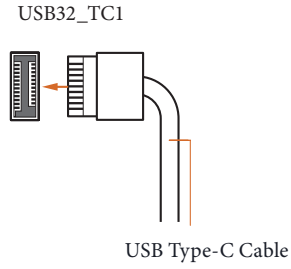
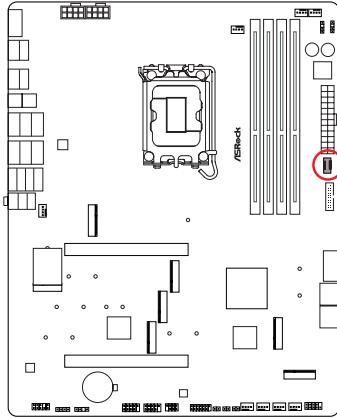

### Front Panel Audio Header

(9-pin HD\_AUDIO1) (see p.7, No. 32)

This header is for connecting audio devices to the front audio panel.

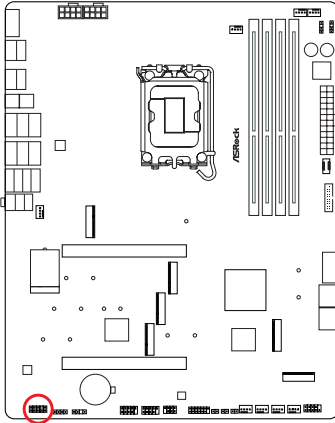

### HD\_AUDIO1

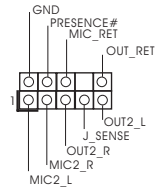

*High Definition Audio supports Jack Sensing, but the panel wire on the chassis must support HDA to function correctly. Please follow the instructions in our manual and chassis manual to install your system.*

### Chassis Fan Connectors

(4-pin CHA\_FAN1) (see p.7, No. 20)

(4-pin CHA\_FAN2) (see p.7, No. 21)

(4-pin CHA\_FAN3) (see p.7, No. 22)

(4-pin CHA\_FAN4) (see p.7, No. 33)

This header allows you to connect Case or Radiator fan. If you plan to connect a 3-pin fan, please connect it to Pin 1-3.

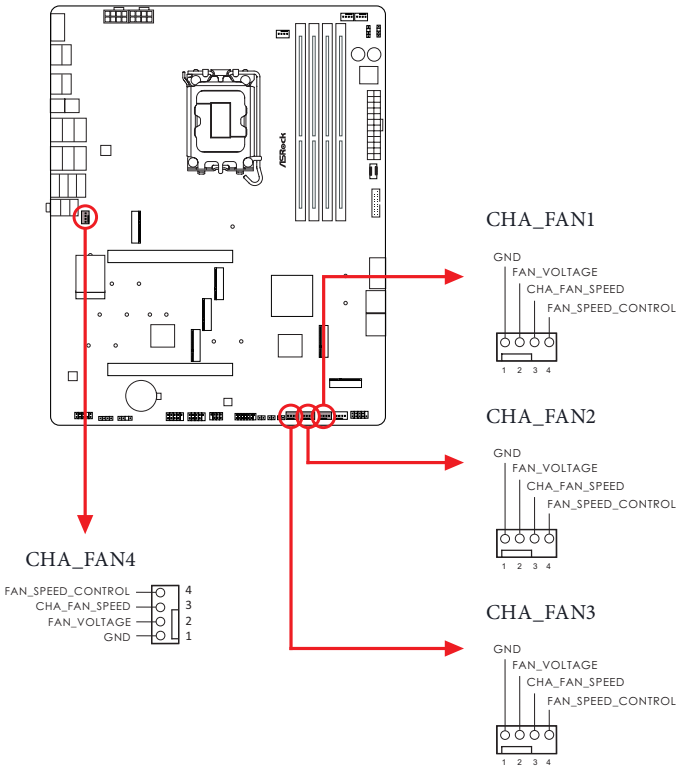



## CPU Fan Connector

(4-pin CPU\_FAN1) (see p.7, No. 3)

This header allows you to connect CPU fan. If you plan to connect a 3-pin fan, please connect it to Pin 1-3.

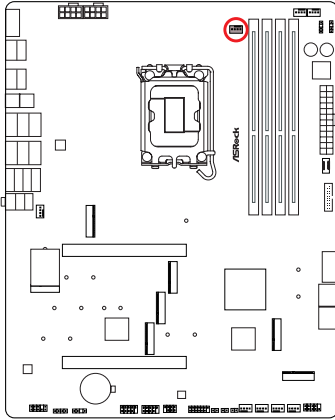

CPU\_FAN1

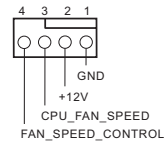

## CPU Fan Connector

(4-pin CPU\_FAN2) (see p.7, No. 6)

This header allows you to connect CPU fan or Water Pump. If you plan to connect a 3-pin fan, please connect it to Pin 1-3.

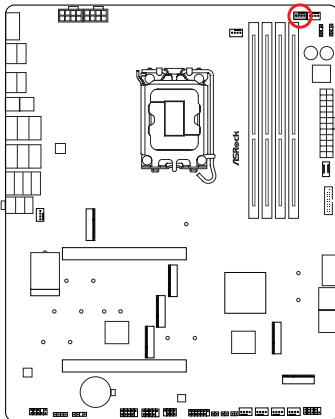

CPU\_FAN2

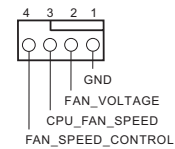

Water Pump Fan Connector  
(4-pin W\_PUMP) (see p.7, No. 19)

This header allows you to connect Water Pump or fan. If you plan to connect a 3-pin fan, please connect it to Pin 1-3.

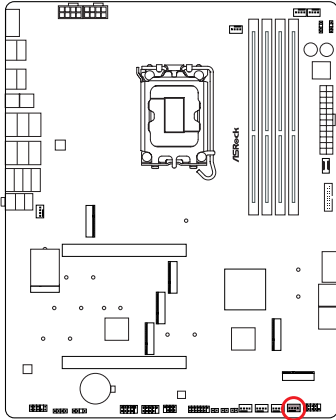

W\_PUMP

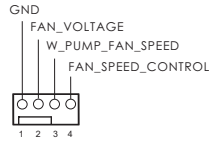

AIO Pump Fan Connector  
(4-pin AIO\_PUMP) (see p.7, No. 7)

This header allows you to connect AIO (All-in-One) pump or fan. If you plan to connect a 3-pin AIO cooler fan, please connect it to Pin 1-3.

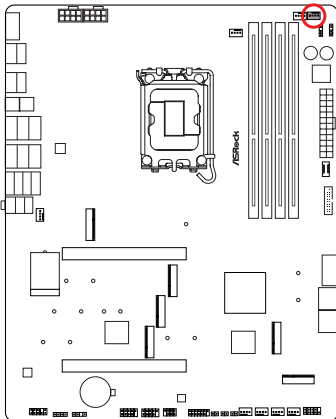

AIO\_PUMP

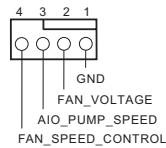

### ATX Power Connector

(24-pin ATXPWR1) (see p.7, No. 12)

This motherboard provides a 24-pin ATX power connector. To use a 20-pin ATX power supply, please plug it along Pin 1 and Pin 13.

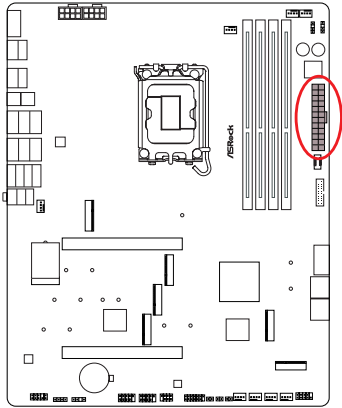

ATXPWR1

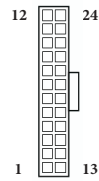

### ATX 12V Power Connectors

(8-pin ATX12V1) (see p.7, No. 1)

(8-pin ATX12V2) (see p.7, No. 2)

This motherboard provides two 8-pin ATX 12V power connectors. To use a 4-pin ATX power supply, please plug it along Pin 1 and Pin 5.

\*Connecting an ATX 12V 8-pin cable to ATX12V2 is optional.

**\*Warning: Please make sure that the power cable connected is for the CPU and not the graphics card. Do not plug the PCIe power cable to this connector.**

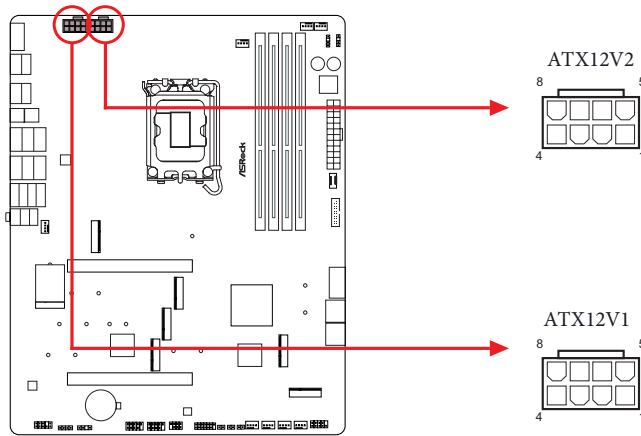

### Thermistor Cable Headers

(2-pin T\_SENSOR1) (see p.7, No. 23)

(2-pin T\_SENSOR2) (see p.7, No. 24)

(2-pin T\_SENSOR3) (see p.7, No. 25)

The Thermistor Cable Headers are used to connect thermistor cables to monitor the temperature of the critical components. Plug the thermistor cables that come with the package to these headers, and then attach the sensor ends to the components to detect their temperature.

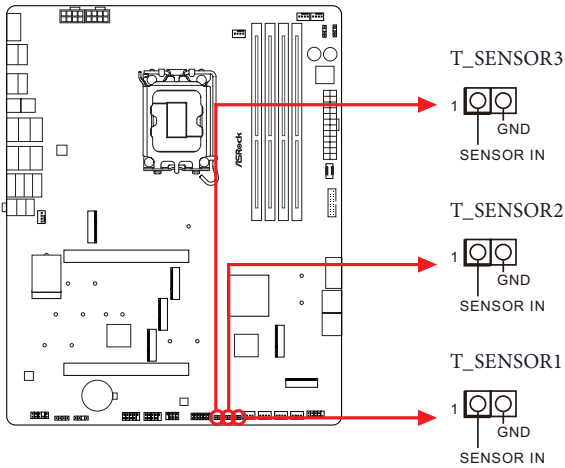

Connect your Thermistor Cables to the **Thermistor Cable Headers (T\_SENSOR1 / T\_SENSOR2 / T\_SENSOR3)** on the motherboard.

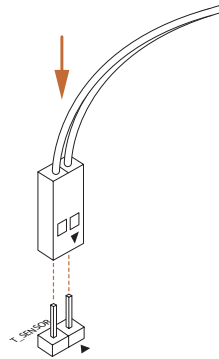

### SPI TPM Header

(13-pin SPI\_TPM\_J1) (see p.7, No. 26)

This connector supports SPI Trusted Platform Module (TPM) system, which can securely store keys, digital certificates, passwords, and data. A TPM system also helps enhance network security, protects digital identities, and ensures platform integrity.

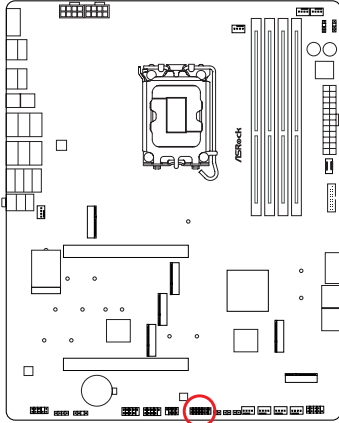

SPI\_TPM\_J1

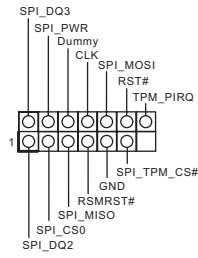

## RGB LED Header

(4-pin RGB\_LED1) (see p.7, No. 31)

This RGB header is used to connect RGB LED extension cable which allow users to choose from various LED lighting effects.

**Caution: Never install the RGB LED cable in the wrong orientation; otherwise, the cable may be damaged.**

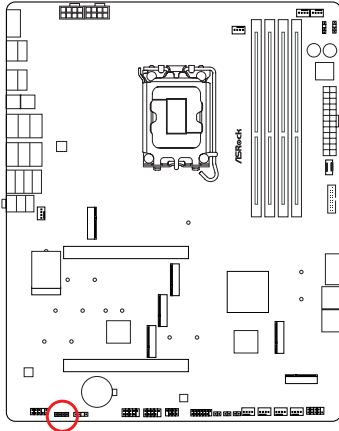

RGB\_LED1



Connect your RGB LED strip to the **RGB LED Header (RGB\_LED1)** on the motherboard.

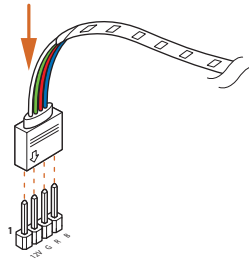

1. Never install the RGB LED cable in the wrong orientation; otherwise, the cable may be damaged.
2. Before installing or removing your RGB LED cable, please power off your system and unplug the power cord from the power supply. Failure to do so may cause damages to motherboard components.



1. Please note that the RGB LED strips do not come with the package.
2. The RGB LED header supports standard 5050 RGB LED strip (12V/G/R/B), with a maximum power rating of 3A (12V) and length within 2 meters.

### Addressable LED Headers

(3-pin ADDR\_LED1) (see p.7, No. 30)

(3-pin ADDR\_LED2) (see p.7, No. 9)

(3-pin ADDR\_LED3) (see p.7, No. 8)

These headers are used to connect Addressable LED extension cables which allow users to choose from various LED lighting effects.

**Caution: Never install the Addressable LED cable in the wrong orientation; otherwise, the cable may be damaged.**

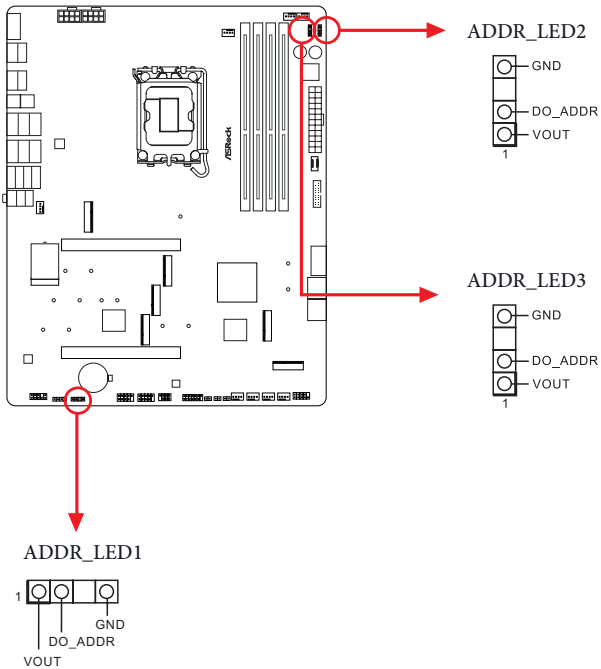

Connect your Addressable RGB LED strips to the **Addressable LED Headers (ADDR\_LED1 / ADDR\_LED2 / ADDR\_LED3)** on the motherboard.

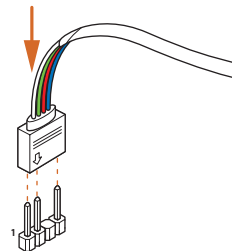





1. Never install the Addressable LED cable in the wrong orientation; otherwise, the cable may be damaged.
2. Before installing or removing your Addressable LED cable, please power off your system and unplug the power cord from the power supply. Failure to do so may cause damages to motherboard components.



1. Please note that the Addressable LED strips do not come with the package.
2. The Addressable LED header supports WS2812B addressable RGB LED strip (5V/Data/GND), with a maximum power rating of 3A (5V) and length within 2 meters.

The ARGB Splitter Cable that comes with the package allows you to extend and connect various addressable RGB LED strips or devices through a single 3-pin Addressable LED Header on the motherboard.

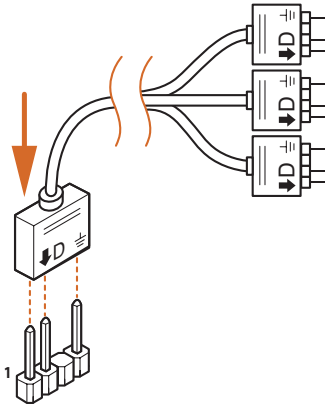

## 2.12 Smart Buttons

The motherboard has four smart switches: Power Button, Reset Button, Clear CMOS Buttons and BIOS Flashback Button, allowing users to quickly turn on/off the system, reset the system, clear the CMOS values or flash the BIOS.

### Power Button

(PWRBTN1) (see p.7, No. 10)

Power Button allows users to quickly turn on/off the system.

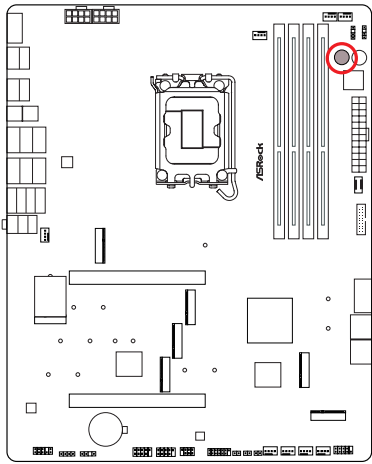

PWRBTN1



### Reset Button

(RSTBTN1) (see p.7, No. 11)

Reset Button allows users to quickly reset the system.

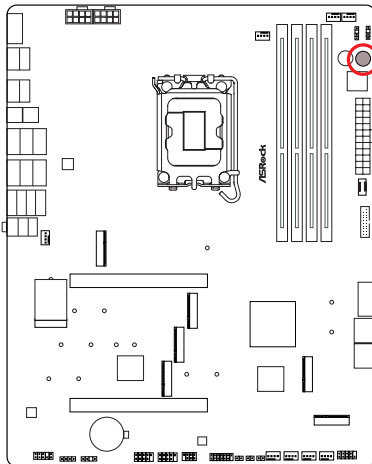

RSTBTN1



### Clear CMOS Button

(CLRCMOS1) (see p.9, No. 13)

Clear CMOS Button allows users to quickly clear the CMOS values.

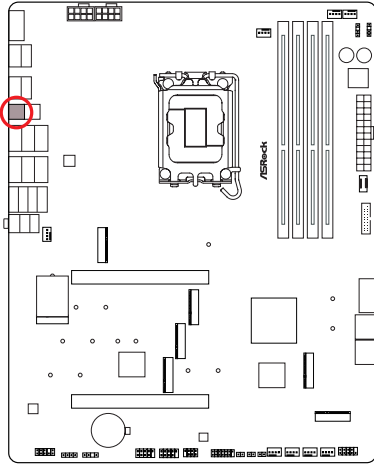

CLRCMOS1



*This function is workable only when you power off your computer and unplug the power supply.*

BIOS Flashback Button

(BIOS\_FB) (see p.9, No. 1)

BIOS Flashback Button allows users to flash the BIOS.

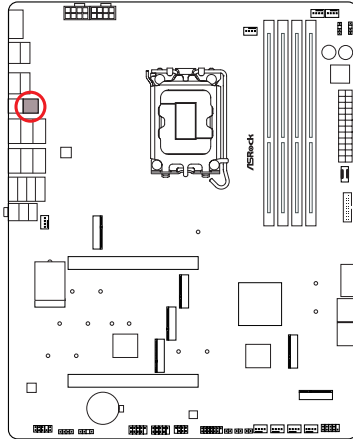

BIOS\_FB



ASRock BIOS Flashback feature allows you to update BIOS without powering on the system, even without CPU.



*Before using the BIOS Flashback function, please suspend BitLocker and any encryption or security relying on the TPM. Make sure that you have already stored and backup-ed the recovery key. If the recovery key is missing while encryption is active, the data will stay encrypted and the system will not boot into the operating system. It is recommended to disable fTPM before updating the BIOS. Otherwise an unpredictable failure may occur.*

To use the USB BIOS Flashback function, Please follow the steps below.

1. Download the latest BIOS file from ASRock's website : <http://www.asrock.com>.
2. Copy the BIOS file to your USB flash drive. Please make sure the file system of your USB flash drive must be FAT32.
3. Extract BIOS file from the zip file.
4. Rename the file to “**creative.rom**” and save it to the root directory of X: USB flash drive.
5. Plug the 24-pin power connector to the motherboard. Then turn on the power supply's AC switch.  
\*There is no need to power on the system.
6. Then plug your USB drive to the USB BIOS Flashback port.
7. Press the BIOS Flashback Switch for about three seconds. Then the LED starts to blink.
8. Wait until the LED stops blinking, indicating that BIOS flashing has been completed.  
\*If the LED light turns solid green, this means that the BIOS Flashback is not operating properly. Please make sure that you plug the USB drive to the USB BIOS Flashback port.  
\*\*If the LED does not light up at all, then please disconnect power from the system and remove/disconnect the CMOS battery from the motherboard for several minutes. Reconnect power and battery and try again.
9. After BIOS flashing is complete, turn off the PC power supply for about two minutes.
10. Then turn on the PC power supply again and now you can press the power button to power on the system.

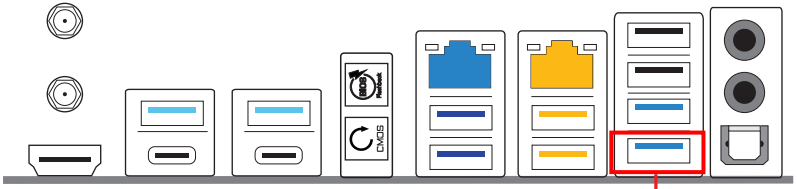

USB BIOS Flashback port

## 2.13 Dr. Debug

Dr. Debug is used to provide code information, which makes troubleshooting even easier. Please see the diagrams below for reading the Dr. Debug codes.

Code	Description
0x10	PEI_CORE_STARTED
0x11	PEI_CAR_CPU_INIT
0x15	PEI_CAR_NB_INIT
0x19	PEI_CAR_SB_INIT
0x31	PEI_MEMORY_INSTALLED
0x32	PEI_CPU_INIT
0x33	PEI_CPU_CACHE_INIT
0x34	PEI_CPU_AP_INIT
0x35	PEI_CPU_BSP_SELECT
0x36	PEI_CPU_SMM_INIT
0x37	PEI_MEM_NB_INIT
0x3B	PEI_MEM_SB_INIT
0x4F	PEI_DXE_IPL_STARTED
0x60	DXE_CORE_STARTED
0x61	DXE_NVRAM_INIT
0x62	DXE_SBRUN_INIT

---

0x63	DXE_CPU_INIT
0x68	DXE_NB_HB_INIT
0x69	DXE_NB_INIT
0x6A	DXE_NB_SMM_INIT
0x70	DXE_SB_INIT
0x71	DXE_SB_SMM_INIT
0x72	DXE_SB_DEVICES_INIT
0x78	DXE_ACPI_INIT
0x79	DXE_CSM_INIT
0x90	DXE_BDS_STARTED
0x91	DXE_BDS_CONNECT_DRIVERS
0x92	DXE_PCI_BUS_BEGIN
0x93	DXE_PCI_BUS_HPC_INIT
0x94	DXE_PCI_BUS_ENUM
0x95	DXE_PCI_BUS_REQUEST_RESOURCES
0x96	DXE_PCI_BUS_ASSIGN_RESOURCES
0x97	DXE_CON_OUT_CONNECT
0x98	DXE_CON_IN_CONNECT



0x99	DXE_SIO_INIT
0x9A	DXE_USB_BEGIN
0x9B	DXE_USB_RESET
0x9C	DXE_USB_DETECT
0x9D	DXE_USB_ENABLE
0xA0	DXE_IDE_BEGIN
0xA1	DXE_IDE_RESET
0xA2	DXE_IDE_DETECT
0xA3	DXE_IDE_ENABLE
0xA4	DXE_SCSI_BEGIN
0xA5	DXE_SCSI_RESET
0xA6	DXE_SCSI_DETECT
0xA7	DXE_SCSI_ENABLE
0xA8	DXE_SETUP_VERIFYING_PASSWORD
0xA9	DXE_SETUP_START
0xAB	DXE_SETUP_INPUT_WAIT
0xAD	DXE_READY_TO_BOOT
0xAE	DXE_LEGACY_BOOT

---

0xAF	DXE_EXIT_BOOT_SERVICES
0xB0	RT_SET_VIRTUAL_ADDRESS_MAP_BEGIN
0xB1	RT_SET_VIRTUAL_ADDRESS_MAP_END
0xB2	DXE_LEGACY_OPROM_INIT
0xB3	DXE_RESET_SYSTEM
0xB4	DXE_USB_HOTPLUG
0xB5	DXE_PCI_BUS_HOTPLUG
0xB6	DXE_NVRAM_CLEANUP
0xB7	DXE_CONFIGURATION_RESET
0xF0	PEI_RECOVERY_AUTO
0xF1	PEI_RECOVERY_USER
0xF2	PEI_RECOVERY_STARTED
0xF3	PEI_RECOVERY_CAPSULE_FOUND
0xF4	PEI_RECOVERY_CAPSULE_LOADED
0xE0	PEI_S3_STARTED
0xE1	PEI_S3_BOOT_SCRIPT
0xE2	PEI_S3_VIDEO_REPOST

0xE3	PEI_S3_OS_WAKE
0x50	PEI_MEMORY_INVALID_TYPE
0x53	PEI_MEMORY_NOT_DETECTED
0x55	PEI_MEMORY_NOT_INSTALLED
0x57	PEI_CPU_MISMATCH
0x58	PEI_CPU_SELF_TEST_FAILED
0x59	PEI_CPU_NO_MICROCODE
0x5A	PEI_CPU_ERROR
0x5B	PEI_RESET_NOT_AVAILABLE
0xD0	DXE_CPU_ERROR
0xD1	DXE_NB_ERROR
0xD2	DXE_SB_ERROR
0xD3	DXE_ARCH_PROTOCOL_NOT_AVAILABLE
0xD4	DXE_PCI_BUS_OUT_OF_RESOURCES
0xD5	DXE_LEGACY_OPROM_NO_SPACE
0xD6	DXE_NO_CON_OUT
0xD7	DXE_NO_CON_IN

---

0xD8	DXE_INVALID_PASSWORD
0xD9	DXE_BOOT_OPTION_LOAD_ERROR
0xDA	DXE_BOOT_OPTION_FAILED
0xDB	DXE_FLASH_UPDATE_FAILED
0xDC	DXE_RESET_NOT_AVAILABLE
0xE8	PEI_MEMORY_S3_RESUME_FAILED
0xE9	PEI_S3_RESUME_PPI_NOT_FOUND
0xEA	PEI_S3_BOOT_SCRIPT_ERROR
0xEB	PEI_S3_OS_WAKE_ERROR

## 2.14 M.2 SSD Installation Guide (M2\_1)

The M.2 is a small size and versatile card edge connector that aims to replace mPCIe and mSATA. The Blazing M.2 Socket (M2\_1, Key M) supports type 2280 PCIe Gen5x4 (128 Gb/s) mode.

### Installing the M.2 SSD

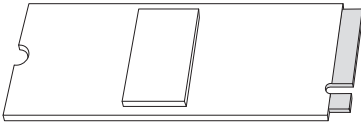

#### Step 1

Prepare a M.2 SSD.

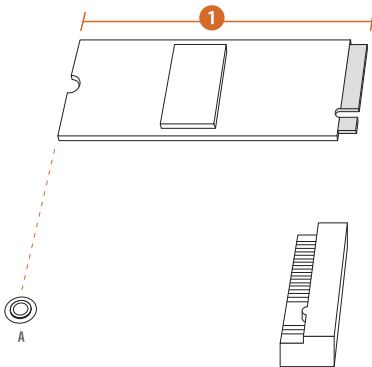

#### Step 2

Depending on the PCB type and length of your M.2 SSD, find the corresponding nut location to be used.

No.	1
Nut Location	A
PCB Length	8cm
Module Type	Type2280

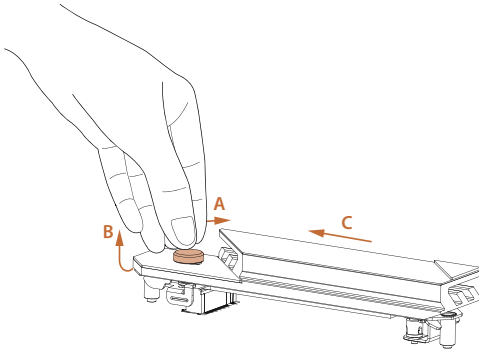

### Step 3

Push and hold the button on the M.2 heatsink (A). Then lift up the heatsink (B) and move it in the direction shown (C).

\*Please remove the protective films on the bottom side of the M.2 heatsink before you install a M.2 SSD.

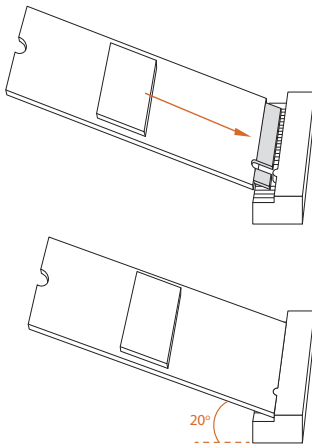

### Step 4

Align and gently insert the M.2 SSD into the M.2 slot. Please be aware that the M.2 SSD only fits in one orientation.

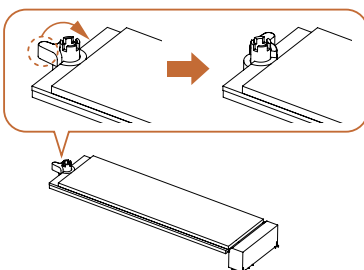

### Step 5

Ensure that the notch at the end of the M.2 SSD aligns with the nut. Then secure the M.2 SSD by turning the nut lock clockwise to its locked position.

**Step 6**

Hook the tab of the M.2 heatsink back onto the standoff.

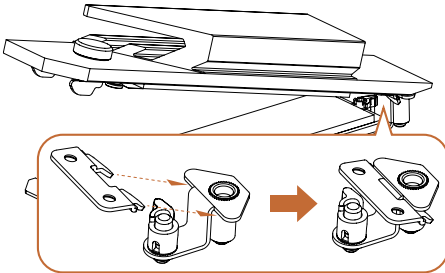
**Step 7**

Press the M.2 heatsink down into place.  
\*Be sure not to press down the button on the M.2 heatsink.

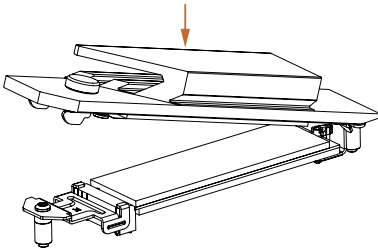
**Step 8**

Complete.

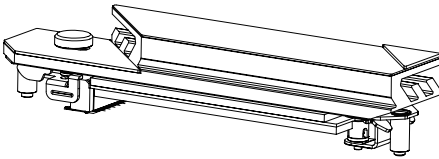

For the latest updates of M.2 SSD support list, please visit our website for details: <http://www.asrock.com>

## 2.15 M.2 SSD Installation Guide (M2\_2, M2\_4 and M2\_5)

The M.2 is a small size and versatile card edge connector that aims to replace mPCIe and mSATA. The Hyper M.2 Sockets (M2\_2, M2\_4 and M2\_5, Key M) support type 2260/2280 PCIe Gen4x4 (64 Gb/s) mode.

\* If PCIE2 is occupied, M2\_4 will be disabled.

### Installing the M.2 SSD

#### Step 1

Prepare a M.2 SSD.

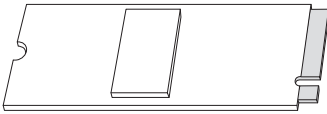

#### Step 2

Depending on the PCB type and length of your M.2 SSD, find the corresponding nut location to be used.

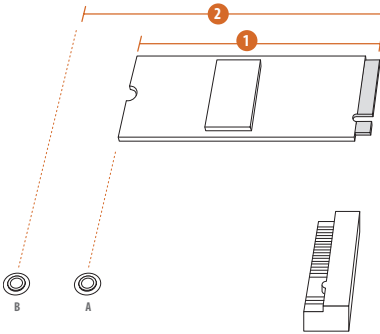

No.	1	2
Nut Location	A	B
PCB Length	6cm	8cm
Module Type	Type2260	Type 2280



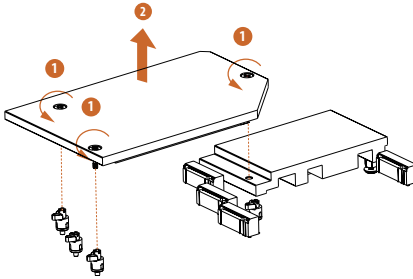

### Step 3

Before installing a M.2 SSD, please loosen the screws to remove the M.2 heatsink.

\*Please remove the protective films on the bottom side of the M.2 heatsink before you install a M.2 SSD.



### Step 4

Peel off the yellow protective film on the nut to be used. Prepare the M.2 standoff that comes with the package, and hand tighten it into the desired nut location on the motherboard.

*Skip Step 4 if your M.2 SSD is Type 2280.*

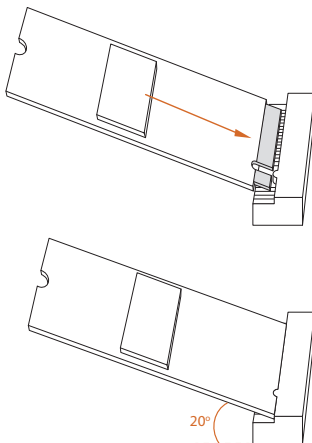

### Step 5

Align and gently insert the M.2 SSD into the M.2 slot. Please be aware that the M.2 SSD only fits in one orientation.

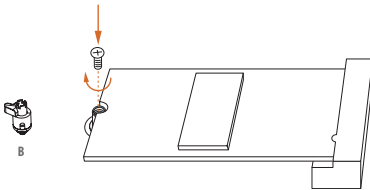

### Step 6

Prepare the M.2 screw that comes with the package, and tighten the screw with a screwdriver to secure the M.2 SSD into place. Please do not overtighten the screw as this might damage the M.2 SSD.

*Skip Step 6 if your M.2 SSD is Type 2280.*

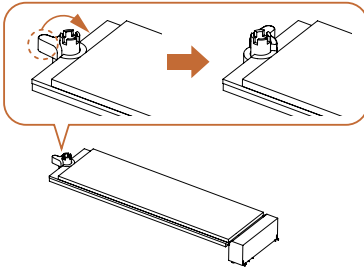

### Step 7

Ensure that the notch at the end of the M.2 SSD aligns with the nut. Then secure the M.2 SSD by turning the nut lock clockwise to its locked position.

*Skip Step 7 if your M.2 SSD is not Type 2280.*

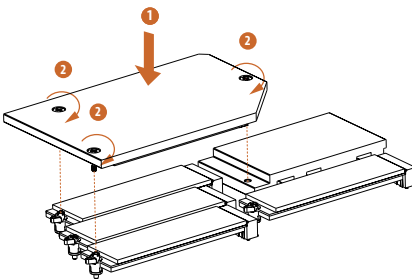

### Step 8

Tighten the screw with a screwdriver to secure the M.2 heatsink into place. Please do not overtighten the screw as this might damage the M.2 heatsink.

For the latest updates of M.2 SSD support list, please visit our website for details: <http://www.asrock.com>

## 2.16 M.2 SSD Installation Guide (M2\_3)

The M.2 is a small size and versatile card edge connector that aims to replace mPCIe and mSATA. The Hyper M.2 Socket (M2\_3, Key M) supports type 2230/2242/2260/2280 SATA3 6.0 Gb/s & PCIe Gen4x4 (64 Gb/s) modes.

### Installing the M.2 SSD

#### Step 1

Prepare a M.2 SSD.

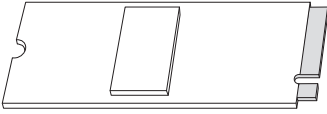

#### Step 2

Depending on the PCB type and length of your M.2 SSD, find the corresponding nut location to be used.

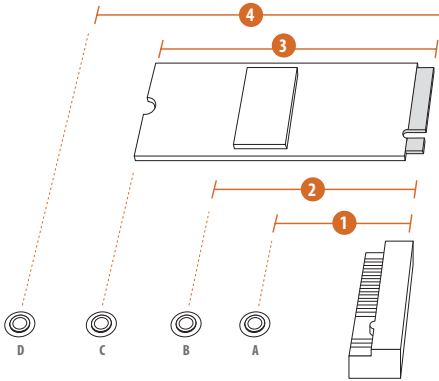

No.	1	2	3	4
Nut Location	A	B	C	D
PCB Length	3cm	4.2cm	6cm	8cm
Module Type	Type2230	Type 2242	Type2260	Type 2280

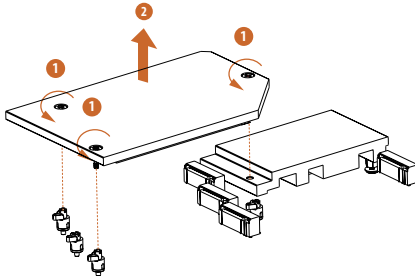

### Step 3

Before installing a M.2 SSD, please loosen the screws to remove the M.2 heatsink.  
\*Please remove the protective films on the bottom side of the M.2 heatsink before you install a M.2 SSD.

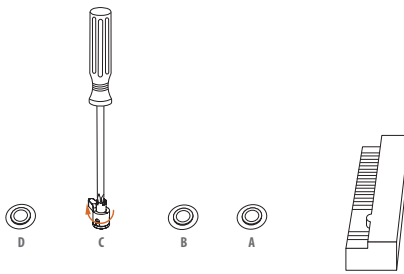

### Step 4

Peel off the yellow protective film on the the nut to be used. Remove the standoff on the nut D with a screwdriver, and tighten it into the desired nut location on the motherboard.  
*Skip Step 4 if your M.2 SSD is Type 2280.*

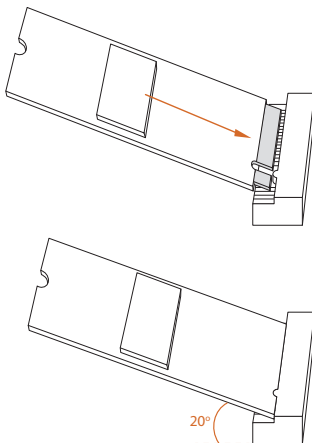

### Step 5

Align and gently insert the M.2 SSD into the M.2 slot. Please be aware that the M.2 SSD only fits in one orientation.

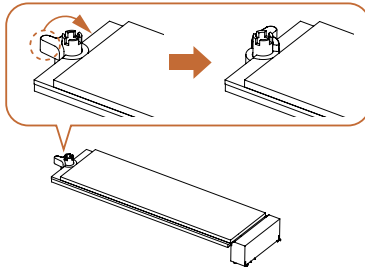
**Step 6**

Ensure that the notch at the end of the M.2 SSD aligns with the nut. Then secure the M.2 SSD by turning the nut lock clockwise to its locked position.

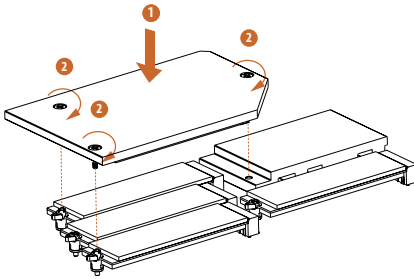
**Step 7**

Tighten the screw with a screwdriver to secure the M.2 heatsink into place. Please do not overtighten the screw as this might damage the M.2 heatsink.

For the latest updates of M.2 SSD support list, please visit our website for details: <http://www.asrock.com>

## 2.17 M.2 SSD Installation Guide (M2\_6)

The M.2 is a small size and versatile card edge connector that aims to replace mPCIe and mSATA. The Hyper M.2 Socket (M2\_6, Key M) supports type 2260/2280 PCIe Gen4x4 (64 Gb/s) mode.

### Installing the M.2 SSD

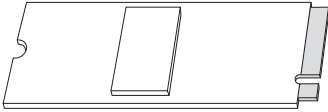

#### Step 1

Prepare a M.2 SSD.

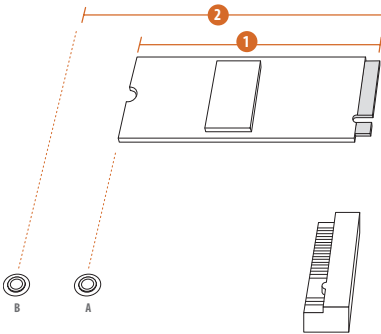

#### Step 2

Depending on the PCB type and length of your M.2 SSD, find the corresponding nut location to be used.

No.	1	2
Nut Location	A	B
PCB Length	6cm	8cm
Module Type	Type2260	Type 2280

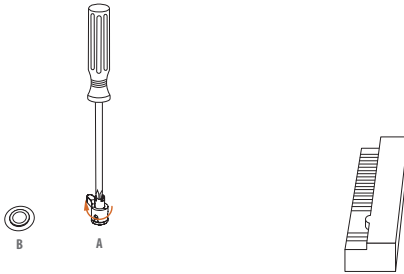

### Step 3

Peel off the yellow protective film on the nut A. Remove the standoff on the nut B with a screwdriver, and move it to the nut A, and then tighten it.

*Skip Step 3 if your M.2 SSD is Type 2280.*

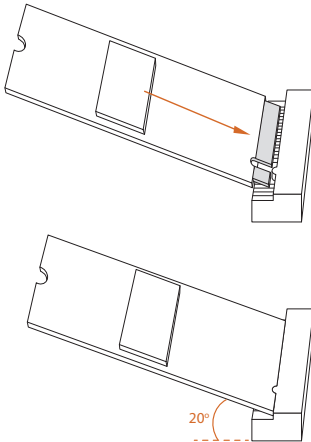

### Step 4

Align and gently insert the M.2 SSD into the M.2 slot. Please be aware that the M.2 SSD only fits in one orientation.

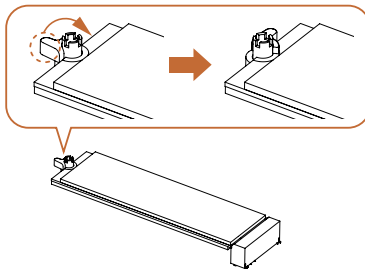

### Step 5

Ensure that the notch at the end of the M.2 SSD aligns with the nut. Then secure the M.2 SSD by turning the nut lock clockwise to its locked position.

For the latest updates of M.2 SSD support list, please visit our website for details: <http://www.asrock.com>

Version 1.0

Published August 2024

Copyright©2024 ASRock INC. All rights reserved.

### Copyright Notice:

No part of this documentation may be reproduced, transcribed, transmitted, or translated in any language, in any form or by any means, except duplication of documentation by the purchaser for backup purpose, without written consent of ASRock Inc.

Products and corporate names appearing in this documentation may or may not be registered trademarks or copyrights of their respective companies, and are used only for identification or explanation and to the owners' benefit, without intent to infringe.

### Disclaimer:

Specifications and information contained in this documentation are furnished for informational use only and subject to change without notice, and should not be constructed as a commitment by ASRock. ASRock assumes no responsibility for any errors or omissions that may appear in this documentation.

To the extent permitted by law, with respect to the contents of this documentation, ASRock does not provide warranty of any kind, either expressed or implied, including but not limited to the implied warranties or conditions of merchantability or fitness for a particular purpose. In no event shall ASRock, its directors, officers, employees, or agents be liable for any indirect, special, incidental, or consequential damages (including damages for loss of profits, loss of business, loss of data, interruption of business and the like), even if ASRock has been advised of the possibility of such damages arising from any defect or error in the documentation or product.



INTEL END USER SOFTWARE LICENSE AGREEMENT  
IMPORTANT - READ BEFORE COPYING, INSTALLING OR USING.

LICENSE. Licensee has a license under Intel's copyrights to reproduce Intel's Software only in its unmodified and binary form, (with the accompanying documentation, the "Software") for Licensee's personal use only, and not commercial use, in connection with Intel-based products for which the Software has been provided, subject to the following conditions:

- (a) Licensee may not disclose, distribute or transfer any part of the Software, and You agree to prevent unauthorized copying of the Software.
- (b) Licensee may not reverse engineer, decompile, or disassemble the Software.
- (c) Licensee may not sublicense the Software.
- (d) The Software may contain the software and other intellectual property of third party suppliers, some of which may be identified in, and licensed in accordance with, an enclosed license.txt file or other text or file.
- (e) Intel has no obligation to provide any support, technical assistance or updates for the Software.

OWNERSHIP OF SOFTWARE AND COPYRIGHTS. Title to all copies of the Software remains with Intel or its licensors or suppliers. The Software is copyrighted and protected by the laws of the United States and other countries, and international treaty provisions. Licensee may not remove any copyright notices from the Software. Except as otherwise expressly provided above, Intel grants no express or implied right under Intel patents, copyrights, trademarks, or other intellectual property rights. Transfer of the license terminates Licensee's right to use the Software.

DISCLAIMER OF WARRANTY. The Software is provided "AS IS" without warranty of any kind, EITHER EXPRESS OR IMPLIED, INCLUDING WITHOUT LIMITATION, WARRANTIES OF MERCHANTABILITY OR FITNESS FOR ANY PARTICULAR PURPOSE.

LIMITATION OF LIABILITY. NEITHER INTEL NOR ITS LICENSORS OR SUPPLIERS WILL BE LIABLE FOR ANY LOSS OF PROFITS, LOSS OF USE, INTERRUPTION OF BUSINESS, OR INDIRECT, SPECIAL, INCIDENTAL, OR CONSEQUENTIAL DAMAGES OF ANY KIND WHETHER UNDER THIS AGREEMENT OR OTHERWISE, EVEN IF INTEL HAS BEEN ADVISED OF THE POSSIBILITY OF SUCH DAMAGES.

LICENSE TO USE COMMENTS AND SUGGESTIONS. This Agreement does NOT obligate Licensee to provide Intel with comments or suggestions regarding the Software. However, if Licensee provides Intel with comments or suggestions for the modification, correction, improvement or enhancement of (a) the Software or (b) Intel products or processes that work with the Software, Licensee grants to Intel a non-exclusive, worldwide, perpetual, irrevocable, transferable, royalty-free license, with the right to sublicense, under Licensee's intellectual property rights, to incorporate or otherwise utilize those comments and suggestions.

TERMINATION OF THIS LICENSE. Intel or the sublicensor may terminate this license at any time if Licensee is in breach of any of its terms or conditions. Upon termination, Licensee will immediately destroy or return to Intel all copies of the Software.

THIRD PARTY BENEFICIARY. Intel is an intended beneficiary of the End User License Agreement and has the right to enforce all of its terms.

U.S. GOVERNMENT RESTRICTED RIGHTS. The Software is a commercial item (as defined in 48 C.F.R. 2.101) consisting of commercial computer software and commercial computer software documentation (as those terms are used in 48 C.F.R. 12.212), consistent with 48 C.F.R. 12.212 and 48 C.F.R. 227.7202-1 through 227.7202-4. You will not provide the Software to the U.S. Government. Contractor or Manufacturer is Intel Corporation, 2200 Mission College Blvd., Santa Clara, CA 95054.

EXPORT LAWS. Licensee agrees that neither Licensee nor Licensee's subsidiaries will export/re-export the Software, directly or indirectly, to any country for which the U.S. Department of Commerce or any other agency or department of the U.S. Government or the foreign government from where it is shipping requires an export license, or other governmental approval, without first obtaining any such required license or approval. In the event the Software is exported from the U.S.A. or re-exported from a foreign destination by Licensee, Licensee will ensure that the distribution and export/re-export or import of the Software complies with all laws, regulations, orders, or other restrictions of the U.S. Export Administration Regulations and the appropriate foreign government.

APPLICABLE LAWS. This Agreement and any dispute arising out of or relating to it will be governed by the laws of the U.S.A. and Delaware, without regard to conflict of laws principles. The Parties to this Agreement exclude the application of the United Nations Convention on Contracts for the International Sale of Goods (1980). The state and federal courts sitting in Delaware, U.S.A. will have exclusive jurisdiction over any dispute arising out of or relating to this Agreement. The Parties consent to personal jurisdiction and venue in those courts. A Party that obtains a judgment against the other Party in the courts identified in this section may enforce that judgment in any court that has jurisdiction over the Parties.

Licensee's specific rights may vary from country to country.

## FCC Compliance Statement



This device complies with Part 15 of the FCC Rules. Operation is subject to the following two conditions:

- (1) this device may not cause harmful interference, and
- (2) this device must accept any interference received, including interference that may cause undesired operation.

This equipment has been tested and found to comply with the limits for a Class B digital device, pursuant to part 15 of the FCC Rules. These limits are designed to provide reasonable protection against harmful interference in a residential installation. This equipment generates, uses and can radiate radio frequency energy and, if not installed and used in accordance with the instructions, may cause harmful interference to radio communications. However, there is no guarantee that interference will not occur in a particular installation. If this equipment does cause harmful interference to radio or television reception, which can be determined by turning the equipment off and on, the user is encouraged to try to correct the interference by one or more of the following measures:

- Reorient or relocate the receiving antenna.
- Increase the separation between the equipment and receiver.
- Connect the equipment into an outlet on a circuit different from that to which the receiver is connected.
- Consult the dealer or an experienced radio/TV technician for help.

## Button Battery Safety Notice

### **WARNING**

- **INGESTION HAZARD:** This product contains a button cell or coin battery.
- **DEATH** or serious injury can occur if ingested.
- A swallowed button cell or coin battery can cause **Internal Chemical Burns** in as little as **2 hours**.
- **KEEP** new and used batteries **OUT OF REACH** of **CHILDREN**
- **Seek immediate medical attention** if a battery is suspected to be swallowed or inserted inside any part of the body.



- Remove and immediately recycle or dispose of used batteries according to local regulations and keep away from children. Do NOT dispose of batteries in household trash or incinerate.
- Even used batteries may cause severe injury or death.
- Call a local poison control center for treatment information.
- Battery type: CR2032
- Battery voltage: 3V
- Non-rechargeable batteries are not to be recharged.
- Do not force discharge, recharge, disassemble, heat above (manufacturer's specified temperature rating) or incinerate. Doing so may result in injury due to venting, leakage or explosion resulting in chemical burns.
- This product contains an irreplaceable battery.
- This icon indicates that a swallowed button battery can cause serious injury or death. Please keep batteries out of sight or reach of children.

## CALIFORNIA, USA ONLY

The Lithium battery adopted on this motherboard contains Perchlorate, a toxic substance controlled in Perchlorate Best Management Practices (BMP) regulations passed by the California Legislature. When you discard the Lithium battery in California, USA, please follow the related regulations in advance.

“Perchlorate Material-special handling may apply, see [www.dtsc.ca.gov/hazardouswaste/perchlorate](http://www.dtsc.ca.gov/hazardouswaste/perchlorate)”

## CALIFORNIA, USA ONLY



WARNING: Cancer and Reproductive Harm  
[www.P65Warnings.ca.gov](http://www.P65Warnings.ca.gov)

## CE Conformity



ASRock INC. hereby declares that this device is in compliance with the essential requirements and other relevant provisions of related Directives. Full text of EU declaration of conformity is available at: <http://www.asrock.com>

ASRock follows the green design concept to design and manufacture our products, and makes sure that each stage of the product life cycle of ASRock product is in line with global environmental regulations. In addition, ASRock disclose the relevant information based on regulation requirements.

Please refer to <https://www.asrock.com/general/about.asp?cat=Responsibility> for information disclosure based on regulation requirements ASRock is complied with.

## UKCA Conformity



ASRock INC. hereby declares that this device is in compliance with the essential requirements and other relevant provisions of related UKCA Directives. Full text of UKCA declaration of conformity is available at: <http://www.asrock.com>

## Consumer Limited Warranty - Australia

Our goods come with guarantees that cannot be excluded under the Australian Consumer Law. You are entitled to a replacement or refund for a major failure and compensation for any other reasonably foreseeable loss or damage caused by our goods. You are also entitled to have the goods repaired or replaced if the goods fail to be of acceptable quality and the failure does not amount to a major failure. If you require assistance please call ASRock Tel : +886-2-28965588 ext.123 (Standard International call charges apply)



### WARNING

THIS PRODUCT CONTAINS A BUTTOON BATTERY

If swallowed, a button battery can cause serious injury or death.  
Please keep batteries out of sight or reach of children.

## Proper Disposal



DO NOT throw the motherboard in municipal waste. This product has been designed to enable proper reuse of parts and recycling. This symbol of the crossed out wheeled bin indicates that the product (electrical and electronic equipment) should not be placed in municipal waste. Check local regulations for disposal of electronic products.

## Class B ITE

この装置は、クラス B 情報技術装置です。この装置は、家庭環境で使用することを目的としていますが、この装置がラジオやテレビジョン受信機に近接して使用されると、受信障害を引き起こすことがあります。取扱説明書に従って正しい取り扱いをして下さい。

## Trademark Information

The terms HDMI® and HDMI High-Definition Multimedia Interface, and the HDMI logo are trademarks or registered trademarks of HDMI Licensing LLC in the United States and other countries.

**HDMI**®  
HIGH-DEFINITION MULTIMEDIA INTERFACE

## European Community Radio Equipment Directive Compliance Statement

This device complies with directive 2014/53/EU issued by the Commission of the European Community. This equipment complies with EU radiation exposure limits set forth for an uncontrolled environment.

This equipment should be installed and operated with minimum distance 20cm between the radiator & your body.

Operations in the 5.15-5.35/6GHz band are restricted to indoor usage only.

	AT	BE	BG	CH	CY	CZ	DE
	DK	EE	EL	ES	FI	FR	HR
	HU	IE	IS	IT	LI	LT	LU
	LV	MT	NL	NO	PL	PT	RO
	SE	SI	SK	TR			



### Radio Frequency Bands and Maximum Power Levels

- Features : Wi-Fi 6E, BT, Wi-Fi 7
- Frequency Range : 2.4 GHz: 2400-2485MHz; 5 GHz: 5150-5350MHz, 5470-5725MHz, 5725-5850MHz; 6 GHz: 5955-6415MHz
- Max Power Level : 2.4 GHz: 20dBm; 5 GHz: 23dBm; 6 GHz: 23dBm

### Compliance Statement of Innovation, Science and Economic Development Canada (ISED)

This device complies with with Innovation, Science and Economic Development Canada's licence-exempt RSS(s). Operation is subject to the following two conditions: (1) this device may not cause interference, and (2) this device must accept any interference, including interference that may cause undesired operation of the device. Operation in the band 5150-5250 MHz is only for indoor use to reduce the potential for harmful interference to co-channel mobile satellite systems. CAN ICES-003(B)/NMB-003(B)

### NCC 無線設備警告聲明

經型式認證合格之低功率射頻電機，非經許可，公司、商號或使用者均不得擅自變更頻率、加大功率或變更原設計之特性及功能。低功率射頻電機之使用不得影響飛航安全及干擾合法通信；經發現有干擾現象時，應立即停用，並改善至無干擾時方得繼續使用。前項合法通信，指依電信法規定作業之無線電通信。低功率射頻電機須忍受合法通信或工業、科學及醫療用電波輻射性電機設備之干擾。

**ASRock Incorporation**

**Contains Wi-Fi 7 module with Bluetooth**

**Intel® Wi-Fi 7 BE200NGW**

**Model: BE200NGW**

FCCID: PD9BE200NG

IC: 1000M-BE200NG

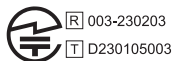

R 003-230203

T D230105003



CCA23Y10590T1

**5GHz band(W52,W53)&6GHz(LPI):indoor use only**

## BSMI 限用物質及元素清單

單元	限用物質及其化學符號					
	鉛 (Pb)	鎘 (Cd)	汞 (Hg)	六價鉻 (Cr <sup>+6</sup> )	多溴聯苯 (PBB)	多溴聯苯醚 (PBDE)
電路板	○	○	○	○	○	○
電子元件	-	○	○	○	○	○
線材	-	○	○	○	○	○
配件	-	○	○	○	○	○
<p>備考 1. “超出 0.1 wt %” 及 “超出 0.01 wt %” 係指限用物質之百分比含量超出百分比含量基準值。</p> <p>備考 2. “○” 係指該項限用物質之百分比含量未超出百分比含量基準值。</p> <p>備考 3. “-” 係指該項限用物質為排除項目。</p>						



## China RoHS

### 电子信息产品污染控制标示

依据中国发布的「电子信息产品污染控制管理办法」及 SJ/T 11364-2014「电子信息产品污染控制标示要求」，电子信息产品应进行标示，藉以向消费者揭露产品中含有的有毒有害物质或元素不致发生外泄或突变从而对环境造成污染或对人身、财产造成严重损害的期限。依上述规定，您可于本产品之印刷电路板上看见图一之标示。图一中之数字为产品之环保使用期限。由此可知此主板之环保使用期限为 10 年。



图一

### 有毒有害物质或元素的名称及含量说明

若您欲了解此产品的有毒有害物质或元素的名称及含量说明，请参照以下表格及说明。

部件名称	有害物质或元素					
	铅 (Pb)	镉 (Cd)	汞 (Hg)	六价铬 (Cr(VI))	多溴联苯 (PBB)	多溴二苯醚 (PBDE)
印刷电路板及电子组件	X	O	O	O	O	O
外部信号连接头及线材	X	O	O	O	O	O

以上表格依据 SJ/T 11364-2014 的规定编制。  
O: 表示该有害物质在该部件所有均质材料中的含量均在 GB/T 26572 规定的限量要求以下。  
X: 表示该有害物质至少在该部件的某一均质材料中的含量超出 GB/T 26572 规定的限量要求。  
备注：此产品所标示之环保使用年限，系指在一般正常使用状况下。